











# Catálogo de produtos

**Linha Máquina**

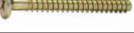









	PARAFUSO MÁQUINA REDONDA SIMPLES	8
	PARAFUSO MÁQUINA CHATA PHILIPS MÉTRICO	8
	PARAFUSO MÁQUINA CHATA PHILLIPS UNS ASME B1.1 - BSW DIN 11	9
	PARAFUSO MÁQUINA PANELA PHILLIPS	9
	PARAFUSO MÁQUINA PANELA PHILLIPS MÉTRICO	10
	PARAFUSO MÁQUINA LENTILHA COM TRAVA	10
	PARAFUSO SEXTAVADO RECALCADO MÉTRICA	11
	PARAFUSO SEXTAVADO RECALCADO ROSCA INTEIRA	11
	PARAFUSO MÁQUINA SEXTAVADO ROSCA INTEIRA	12
	PARAFUSO MÁQUINA SEXTAVADO ROSCA MÉTRICA	12
	PARAFUSO MÁQUINA LENTILHA COMBINADA	13
	PARAFUSO MÁQUINA TAMPINHA 13 PHILLIPS	13
	PARAFUSO MÁQUINA TAMPINHA ESTRUTURAL ALLEN	14
	PARAFUSO MÁQUINA TAMPINHA 13 PHILLIPS	14
	PARAFUSO MÁQUINA ESTRUTURAL TAMPINHA 13 ALLEN	14
	PARAFUSO MÁQUINA FRANCÊS SEM PORCA	15
	PARAFUSO MÁQUINA FRANCÊS SEM PORCA MÉTRICA	15
	BARRA ROSCADA	16
	BARRA ROSCADA MÉTRICA	16
	PARAFUSO TRILOBULAR CHATA PHILLIPS MÉTRICO	17
	PARAFUSO TRILOBULAR CHATA PHILLIPS MÉTRICO	17
	PARAFUSO TRILOBULAR SEXTAVADA FLANGEADA MÉTRICA	18
	HASTE DE FERRO PRISIONEIRO	18
	HASTE ROSCADA PARA TELHA	19
	PARAFUSO SUPORTE INVISÍVEL	19
	KIT HASTE PARA TELHA COM CONJUNTO DE VEDAÇÃO	19
	CABEÇA CILINDRICA SEXTAVADO INTERNO - SÉRIE POLEGADA ASMEB 18.3	20
	CABEÇA CILINDRICA BAIXA SEXTAVADO INTERNO - SÉRIE MÉTRICA DIN 7984	20
	CABEÇA CILINDRICA BAIXA SEXTAVADO INTERNO - SÉRIE MÉTRICA DIN 912	21
	CABEÇA CILINDRICA BAIXA SEXTAVADO INTERNO - SÉRIE MÉTRICA DIN 7984	22

**Linha Madeira**

	PARAFUSO MADEIRA CHIP CABEÇA CHATA PHILLIPS	25
	PARAFUSO MADEIRA CHIP CABEÇA PANELA PHILLIPS	25
	PARAFUSO MADEIRA CHIP CABEÇA FLANGEADA PHILLIPS	26

	PARAFUSO MADEIRA CHIP OVAL PHILLIPS	26
	PARAFUSO MADEIRA CABEÇA CHATA PHILLIPS	27
	PARAFUSO MADEIRA TAMPINHA PHILLIPS	27
	PARAFUSO ESTRUTURAL TAMPINHA PHILLIPS	28
	PARAFUSO ESTRUTURAL TAMPINHA ALLEN	28
	PARAFUSO ESTRUTURAL ESCAREADO PHILLIPS	29
	PARAFUSO ESTRUTURAL ESCAREADO ALLEN	29
	PINO GIROFIX DE AÇO	30
	CASTANHAS ZAMAC	30

## Linha Auto Atarraxante

	PARAFUSO AUTO ATARRAXANTE CABEÇA CHATA PHILLIPS	33
	PARAFUSO AUTO ATARRAXANTE CABEÇA PANELA PHILLIPS	33
	PARAFUSO AUTO ATARRAXANTE FLANGEADA FENDA COMBINADA	34
	PARAFUSO AUTO ATARRAXANTE CABEÇA PANELA PHILLIPS PONTA PILOTO	34
	PARAFUSO PLASTIC CABEÇA PANELA PHILLIPS	35
	PARAFUSO PLASTIC CABEÇA FLANGEADA PHILLIPS	35
	PARAFUSO AUTO ATARRAXANTE CABEÇA PANELA FENDA SIMPLES	36
	PARAFUSO PARA TELHA COM E SEM CONJUNTO DE VEDAÇÃO	36
	PARAFUSO FLANGEADO CABEÇA PHILLIPS PONTA DE AGULHA	37
	PARAFUSO TROMBETA CABEÇA PHILLIPS PONTA DE AGULHA	37
	PARAFUSO AUTO-FIX SEXTAVADO FLANGEADO FENDA SIMPLES	38

## Linha Construção Civil

	PARAFUSO SEXTAVADO ROSCA SOBERBA	41
	PBSAV / PARAFUSO AUTOPERFORANTE PONTA BROCA CABEÇA SEXTAVADA C/ ARRUELA VULCANIZADA	41
	PBSAV / PARAFUSO AUTOPERFORANTE PONTA BROCA CABEÇA SEXTAVADA C/ ARRUELA VULCANIZADA -PASSIVADO	42
	PBSAV COSTURA / PARAF. AUTOP. PONTA BROCA # 1 C/SEXTAVADA C/ ARRUELA VULCANIZADA	42
	PBS CUPPED / PARAFUSO AUTOPERFORANTE PONTA BROCA CABEÇA SEXTAVADA CUPPED C/ ARRUELA DE EPDM	42
	PBS CUPPED / PARAFUSO AUTOPERFORANTE PONTA BROCA CABEÇA SEXTAVADA CUPPED C/ ARRUELA DE EPDM	42
	PBSF (LUH) / PARAFUSO AUTOPERFORANTE PONTA BROCA CABEÇA SEXTAVADA FLANGEADA LUH C/ ARRUELA DE EPDM	42
	PBS CUPPED / PARAFUSO AUTOPERFORANTE PONTA BROCA CABEÇA SEXTAVADA CUPPED C/ ARRUELA DE EPDM	43
	PBS CUPPED / PARAFUSO AUTOPERFORANTE PONTA BROCA CABEÇA SEXTAVADA CUPPED C/ ARRUELA DE EPDM	43
	PBS CUPPED COSTURA / PARAF. AUTOP. PONTA BROCA # 1 C/SEXTAVADA CUPPED COSTURA C/ ARRUELA DE EPDM	43
	PBSF (LUH) COSTURA / PARAFUSO AUTOPERFORANTE PONTA BROCA CABEÇA SEXTAVADA FLANGEADA LUH C/ ARRUELA DE EPDM	43
	PBS CUPPED COSTURA / PARAF. AUTOP. PONTA BROCA # 1 CABEÇA SEXTAVADA CUPPED COSTURA C/ ARRUELA DE EPDM	43

	PBS CUPPED COSTURA / PARAF. AUTOP. PONTA BROCA # 1 C/SEXTAVADA CUPPED COSTURA C/ ARRUELA DE EPDM	44
	PAS CUPPED COSTURA / PARAFUSO AUTOPERFURANTE PONTA AGULHA CABEÇA SEXTAVADA CUPPED C/ ARRUELA DE EPDM	44
	PBS CUPPED #5 / PARAFUSO AUTOPERFURANTE PONTA BROCA # 5 CABEÇA SEXTAVADA CUPPED C/ ARRUELA DE EPDM	44
	PBS CUPPED INSULATION / PARAFUSO AUTOPERFURANTE PONTA BROCA ROSCA DUPLA CABEÇA SEXTAVADA CUPPED C/ ARRUELA DE EPDM	44
	PBS CUPPED INSULATION / PARAFUSO AUTOPERFURANTE PONTA BROCA ROSCA DUPLA CABEÇA SEXTAVADA CUPPED C/ ARRUELA DE EPDM -PASSIVADO	44
	PBS CUPPED INSULATION PARAFUSO AUTOPERFURANTE PONTA BROCA ROSCA DUPLA CABEÇA SEXTAVADA CUPPED C ARRUELA DE EPDM	44
	PBS CUPPED INSULATION / PARAFUSO AUTOPERFURANTE PONTA BROCA ROSCA DUPLA CABEÇA SEXTAVADA CUPPED C/ ARRUELA DE EPDM	45
	PBS CUPPED INSULATION #1 / PARAFUSO AUTOPERFURANTE PONTA BROCA #1 ROSCA DUPLA CABEÇA SEXTAVADA CUPPED C/ ARRUELA DE EPDM	45
	POS CUPPED / PARAF. AUTOP. PONTA # 17 OGIVADA ROSCA HI-LO C/SEXTAVADA CUPPED C/ ARRUELA DE EPDM	45
	POS CUPPED / PARAF. AUTOP. PONTA # 17 OGIVADA ROSCA HI-LO CABEÇA SEXTAVADA CUPPED C/ ARRUELA DE EPDM	45
	POS CUPPED INSULATION / PAR AUT PONTA # 17 OGIVADA R/DUPLA E HI-LO C/SEXT. CUPPED C/ ARRUELA EPDM	45
	POS CUPPED INSULATION / PAR AUT PONTA # 17 OGIVADA R/DUPLA E HI-LO C/SEXT CUPPED C/ ARRUELA DE EPDM	45
	POS CUPPED INSULATION / PAR AUT. PONTA # 17 OGIVADA R/DUPLA E HI-LO C/SEXT CUPPED C/ ARRUELA EPDM	45
	CONCRETO / PARAFUSO PARA FIXAÇÃO DIRETA EM CONCRETO ROSCA HI-LO CABEÇA SEXTAVADA PHILLIPS	46
	CONCRETO / PARAFUSO PARA FIXAÇÃO DIRETA EM CONCRETO ROSCA HI-LO CABEÇA CHATA PHILLIPS	46
	PBS / PARAFUSO AUTOPERFURANTE PONTA BROCA CABEÇA SEXTAVADA	46
	PBS / PARAFUSO AUTOPERFURANTE PONTA BROCA CABEÇA SEXTAVADA- RUSPERT	46
	PBS / PARAFUSO AUTOPERFURANTE PONTA BROCA CABEÇA SEXTAVADA- INOX 410 PASSIVADO	46
	PBRX / PARAFUSO AUTOPERFURANTE PONTA BROCA CABEÇA REDONDA CHAVE TORX (T-30)	46
	PBP / PARAFUSO AUTOPERFURANTE PONTA BROCA CABEÇA PANELA PHILLIPS	47
	PBP / PARAFUSO AUTOPERFURANTE PONTA BROCA CABEÇA PANELA PHILLIPS/INOX 410 PASSIVADO	47
	PBC / PARAFUSO AUTOPERFURANTE PONTA BROCA CABEÇA CHATA PHILLIPS	48
	PBC / PARAFUSO AUTOPERFURANTE PONTA BROCA CABEÇA CHATA PHILLIPS/INOX 410 PASSIVADO	48
	PBF / PARAFUSO AUTOPERFURANTE PONTA BROCA CABEÇA FLANGEADA PHILLIPS	48
	PBF / PARAFUSO AUTOPERFURANTE PONTA BROCA CABEÇA FLANGEADA PHILLIPS COLORS	49
	PBF / PARAFUSO AUTOPERFURANTE PONTA BROCA CABEÇA FLANGEADA PHILLIPS RUSPERT	49
	PBF / PARAFUSO AUTOPERFURANTE PONTA BROCA CABEÇA FLANGEADA PHILLIPS INOX 410 PASSIVADO	49
	PBT / PARAFUSO AUTOPERFURANTE PONTA BROCA CABEÇA TROMBETA PHILLIPS	49
	PBEA / PARAF AUTOP PONTA BROCA CABEÇA CHATA PHILLIPS C/ ESTRIAS ESCARIADORAS E ASAS DE EXPANSAO	49
	PBEA / PARAF AUTOP PONTA BROCA CABEÇA CHATA PHILLIPS C/ ESTRIAS ESCARIADORAS E ASAS DE EXPANSAO	49

	PBEA / PARAF AUTOP PONTA BROCA CABEÇA CHATA PHILLIPS C/ ESTRIAS ESCARIADORAS E ASAS DE EXPANSAO	50
	PBA / PARAF AUTOP PONTA BROCA CABEÇA CHATA PHILLIPS C/ ASAS DE EXPANSAO	50
	PBEE / PARAFUSO AUTOPERFORANTE PONTA BROCA CABEÇA CHATA ESCALONADA PHILLIPS C/ 8 ESTRIAS ESCARIADORAS	50
	PAEE / PARAFUSO AUTOP PONTA ESPADA ROSCA HI-LO CABEÇA CHATA ESCALONADA PHILLIPS C/ 8 ESTRIAS ESCARIADORAS RUSPERT	50
	MF-FU / BUCHA UNIVERSAL TIPO FU MULTI-USO EM NYLON	50
	MF-U / BUCHA UNIVERSAL DE TORSAO MULTI-USO EM NYLON	50
	MF-B / BUCHA BORBOLETA EM NYLON	50
	MF-S / BUCHA DE FIXAÇÃO EM NYLON (PONTA DE ESTOQUE)	51
	PBE-MAD / PARAFUSO AUTOPERFORANTE PONTA BROCA CABEÇA CHATA TORX / PHILLIPS C/ ESTRIAS ESCARIADORAS ROSCA MADEIRA (PONTA DE ESTOQUE)	51

Linha Porcas

	PORCA SEXTAVADA	53
--	-----------------	----

Linha Rebites

	REBITE DE REPUXO ALUMÍNIO	55
	REBITE MACIÇO ALUMÍNIO CABEÇA LENTILHA	55
	REBITE MACIÇO ALUMÍNIO CABEÇA REDONDA	56
	REBITE MACIÇO ALUMÍNIO CABEÇA PLANA	56
	REBITE MACIÇO FERRO CABEÇA REDONDA	57
	REBITE MACIÇO FERRO CABEÇA PLANA	57

INOVE  
FIX

- Parafusos com bitolas de 3mm à 10mm com comprimento até 200mm.
- Parafusos em multiestágios de até 180mm e bitola de até 5/8" com diâmetro de cabeça de até 26mm.
- Parafusos especiais conforme desenho técnico ou amostra.
- Porcas até M10.

## Conheça um pouco da Inove-Fix

A Inove-fix é uma empresa especializada em fixadores de alta qualidade, oferecendo uma linha completa de produtos que atendem às necessidades de fixação em diversos segmentos. Com o compromisso de fornecer soluções eficientes e duradouras, nossos fixadores são projetados para garantir a segurança e a confiabilidade das estruturas e equipamentos.



[www.inovefix.com.br](http://www.inovefix.com.br)

Nossa equipe é formada por profissionais experientes e dedicados, que estão sempre atualizados sobre as tendências e tecnologias do mercado. Além disso, buscamos manter preços justos e competitivos, para que nossos clientes possam obter os melhores fixadores sem comprometer o orçamento. Seja para aplicações industriais, construção civil ou qualquer outro setor, a Inove-fix é a escolha ideal para quem busca qualidade, variedade e excelente custo-benefício em fixadores.





**Linha  
máquina**

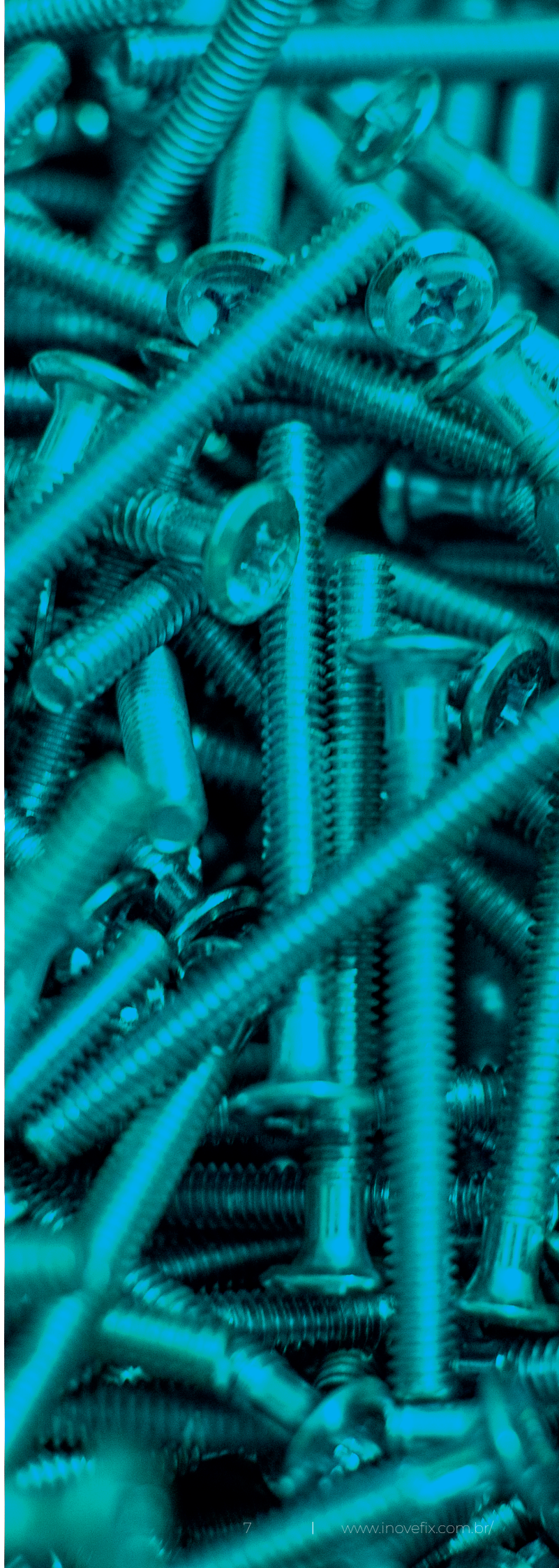

## Parafuso máquina Redonda Simples

Material: Aço baixo carbono  
Acabamento: Zincado ou Bicromatizado

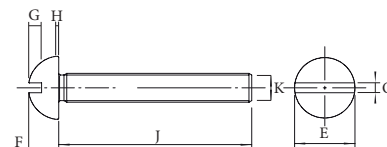

### Dimensões

Diâmetro K	1/8"	5/32"	3/16"	1/4"	5/16"	3/8"
E (máx)	6,00	7,80	9,10	12,00	15,00	18,00
F (máx)	2,40	3,00	3,50	4,40	5,50	6,50
O (máx)	1,10	1,30	1,50	1,90	2,10	2,30
passo	0,63	0,79	1,06	1,27	1,41	1,59

J	1/4"	R\$ 8,91	R\$ 14,08	R\$ 20,86			
5/16"	R\$ 9,46	R\$ 15,62	R\$ 23,56				
3/8"	R\$ 9,96	R\$ 17,92	R\$ 25,48	R\$ 48,91			
1/2"	R\$ 12,02	R\$ 20,23	R\$ 29,83	R\$ 56,60	R\$ 95,98		
5/8"	R\$ 13,91	R\$ 22,66	R\$ 32,52	R\$ 62,96	R\$ 107,59		
3/4"	R\$ 15,81	R\$ 25,35	R\$ 37,38	R\$ 71,16	R\$ 121,04	R\$ 189,76	
7/8"	R\$ 16,81	R\$ 26,45	R\$ 39,55	R\$ 70,59	R\$ 120,64	R\$ 194,56	
1"	R\$ 19,14	R\$ 29,76	R\$ 43,47	R\$ 79,58	R\$ 131,02	R\$ 208,75	
1.1/4"	R\$ 23,28	R\$ 35,39	R\$ 50,81	R\$ 90,88	R\$ 155,23	R\$ 240,00	
1.1/2"	R\$ 24,63	R\$ 39,19	R\$ 54,99	R\$ 99,78	R\$ 167,09	R\$ 252,43	
1.3/4"	R\$ 29,52	R\$ 43,12	R\$ 61,90	R\$ 109,44	R\$ 167,97	R\$ 282,83	
2"	R\$ 31,23	R\$ 49,22	R\$ 69,74	R\$ 124,20	R\$ 206,40	R\$ 314,32	
2.1/4"		R\$ 53,83	R\$ 77,57	R\$ 133,98	R\$ 217,14	R\$ 339,40	
2.1/2"		R\$ 58,34	R\$ 82,22	R\$ 146,41	R\$ 244,08	R\$ 371,05	
2.3/4"			R\$ 89,54	R\$ 152,38	R\$ 266,21	R\$ 395,41	
3"		R\$ 68,37	R\$ 96,30	R\$ 170,89	R\$ 288,33	R\$ 424,16	
3.1/2"			R\$ 110,94	R\$ 176,22	R\$ 299,22	R\$ 480,91	
4"			R\$ 125,92	R\$ 216,95	R\$ 360,79	R\$ 536,26	

Preço de lista por cento

## Parafuso máquina Chata Philips Métrico

Material: Aço baixo carbono  
Acabamento: Zincado ou Bicromatizado

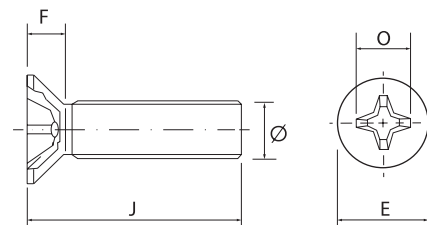

### Dimensões

Diâmetro	M3	M4	M5	M6	M8
E (máx)	5,60	7,50	9,20	11,00	14,50
F (máx)	1,65	2,20	2,50	3,00	4,00
O (máx)	1,00	2,00	2,00	3,00	4,00
passo	0,50	0,70	0,80	1,00	1,25

J	6	R\$ 8,89	R\$ 13,33			
8	R\$ 9,97	R\$ 14,50				
10	R\$ 11,70	R\$ 16,39	R\$ 21,87			
12	R\$ 12,56	R\$ 17,66	R\$ 24,76	R\$ 33,91		
16	R\$ 13,43	R\$ 20,61	R\$ 29,28	R\$ 41,73	R\$ 80,40	
18		R\$ 26,31	R\$ 31,96	R\$ 44,61	R\$ 89,04	
20	R\$ 15,37	R\$ 27,05	R\$ 35,05	R\$ 47,08	R\$ 95,01	
25	R\$ 17,75	R\$ 27,79	R\$ 40,81	R\$ 56,75	R\$ 111,07	
30	R\$ 19,48	R\$ 33,03	R\$ 47,28	R\$ 64,57	R\$ 125,47	
35		R\$ 33,35	R\$ 53,46	R\$ 74,24	R\$ 142,35	
40		R\$ 39,89	R\$ 59,22	R\$ 83,09	R\$ 160,25	
45		R\$ 44,00	R\$ 65,39	R\$ 88,24	R\$ 174,45	
50		R\$ 47,69	R\$ 71,36	R\$ 101,82	R\$ 190,71	
60			R\$ 91,72	R\$ 125,68	R\$ 222,00	
70				R\$ 142,76	R\$ 249,98	
80				R\$ 160,46	R\$ 283,53	

Preço de lista por cento



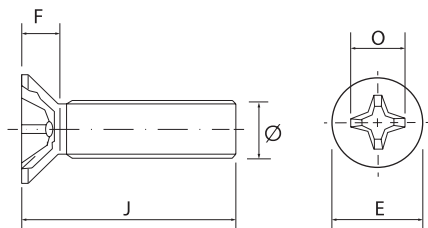

### Parafuso máquina

#### chata phillips

UNS ASME B1.1 - BSW DIN 11

Material: Aço baixo carbono

Acabamento: Zincado ou Bicromatizado

### Dimensões

Diâmetro	1/8"	9/64"	5/32"	3/16"	1/4"	5/16"
E (máx)	5,50	6,70	7,00	9,00	11,00	14,00
F (máx)	1,50	2,00	1,90	2,30	2,80	3,40
O (máx)	1,00	2,00	2,00	3,00	4,00	4,00
fpp/rosca	40/BSW	32/UNC	32/BSW	24/BSW	20/UNC	

<b>J</b>	1/4"	R\$ 10,73		R\$ 13,44			
	5/16"	R\$ 11,49		R\$ 15,13	R\$ 17,56		
	3/8"	R\$ 12,46		R\$ 16,08	R\$ 21,98	R\$ 33,70	
	1/2"	R\$ 14,19		R\$ 18,19	R\$ 24,25	R\$ 38,23	R\$ 70,42
	5/8"	R\$ 15,48	R\$ 18,39	R\$ 20,93	R\$ 27,85	R\$ 43,38	sob consulta
	3/4"	R\$ 16,89		R\$ 23,04	R\$ 31,14	R\$ 49,65	sob consulta
	7/8"	R\$ 18,19		R\$ 24,84	R\$ 34,02	R\$ 56,34	R\$ 98,82
	1"	R\$ 20,02		R\$ 27,79	R\$ 38,75	R\$ 62,11	R\$ 108,34
	1.1/4"	R\$ 24,84		R\$ 33,46	R\$ 45,13	R\$ 72,91	sob consulta
	1.1/2"	R\$ 27,32	R\$ 31,86	R\$ 38,10	R\$ 51,81	R\$ 86,08	R\$ 146,26
	1.3/4"	R\$ 31,00		R\$ 43,37	R\$ 58,61	R\$ 97,30	sob consulta
	2"	R\$ 33,92	R\$ 35,65	R\$ 48,01	R\$ 72,48	R\$ 110,16	sob consulta
	2.1/4"			R\$ 62,46	R\$ 81,23	R\$ 128,67	sob consulta
	2.1/2"	R\$ 35,23		R\$ 67,32	R\$ 86,17	R\$ 141,94	sob consulta
	2.3/4"				R\$ 95,22	R\$ 158,71	sob consulta
	3"		R\$ 59,12		R\$ 98,93	R\$ 166,74	sob consulta
	3.1/2"				R\$ 115,91	R\$ 190,82	sob consulta
	4"	R\$ 53,50			R\$ 130,52	R\$ 215,41	sob consulta

Preço de lista por cento

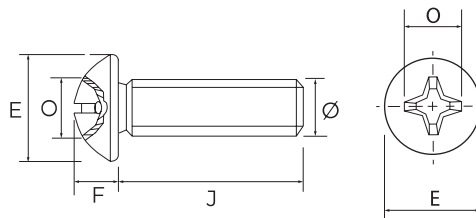

### Parafuso máquina

#### Panela Phillips

Material: Aço baixo carbono

Acabamento: Zincado ou Bicromatizado

### Dimensões

Diâmetro	1/4"
E (máx)	14,50
F (máx)	3,8
O (máx)	3,0
Rosca - Fio	UNC-20

<b>J</b>	1/2"	R\$ 45,79
	5/8"	R\$ 52,56
	3/4"	R\$ 56,78
	1"	R\$ 64,53
	1.1/4"	R\$ 72,73

Preço de lista por cento

## Parafuso máquina Panela Phillips

Material: Aço baixo carbono  
Acabamento: Zincado ou Bicromatizado

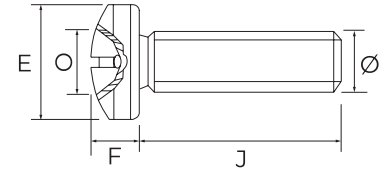

### Dimensões

Diâmetro	M3	M4	M5	M6	M8
E (máx)	6,00	8,00	10,00	12,00	16,00
F (máx)	2,52	3,25	3,95	4,75	6,18
O (máx)	1,00	2,00	2,00	3,00	4,00
passo	0,50	0,70	0,80	1,00	1,25

J	6	8	10	12	16	18	20	25	30	35	40	45	50	60	70	80
	R\$ 11,70	R\$ 12,78	R\$ 13,86	R\$ 14,29	R\$ 16,45	R\$ 18,40	R\$ 19,70	R\$ 23,21	R\$ 25,68	R\$ 27,66	R\$ 29,39	R\$ 31,86	R\$ 32,68	R\$ 41,42	R\$ 46,87	R\$ 53,25
		R\$ 20,83	R\$ 22,41	R\$ 24,10	R\$ 25,59	R\$ 30,64	R\$ 32,92	R\$ 38,19	R\$ 42,09	R\$ 47,48	R\$ 52,76	R\$ 51,81	R\$ 64,04	R\$ 70,95	R\$ 77,54	R\$ 81,94
			R\$ 29,39	R\$ 32,68	R\$ 41,42	R\$ 44,40	R\$ 46,87	R\$ 58,24	R\$ 64,60	R\$ 66,53	R\$ 70,95	R\$ 77,54	R\$ 90,69	R\$ 96,06	R\$ 103,66	R\$ 103,66
					R\$ 53,25	R\$ 58,24	R\$ 64,60	R\$ 70,95	R\$ 77,54	R\$ 81,94	R\$ 90,69	R\$ 96,06	R\$ 103,66	R\$ 103,66	R\$ 129,38	R\$ 146,26
					R\$ 72,58	R\$ 77,54	R\$ 81,94	R\$ 90,69	R\$ 96,06	R\$ 103,66	R\$ 103,66	R\$ 129,38	R\$ 146,26	R\$ 146,26	R\$ 164,58	R\$ 164,58
					R\$ 150,91	R\$ 150,91	R\$ 168,53	R\$ 188,81	R\$ 176,10	R\$ 225,20	R\$ 240,16	R\$ 264,62	R\$ 237,64	R\$ 265,21	R\$ 303,08	R\$ 303,08
									R\$ 176,10	R\$ 225,20	R\$ 240,16	R\$ 264,62	R\$ 237,64	R\$ 265,21	R\$ 303,08	R\$ 349,18

Preço de lista por cento

## Parafuso máquina Lentilha com trava

Material: Aço baixo carbono  
Acabamento: Zincado ou Bicromatizado

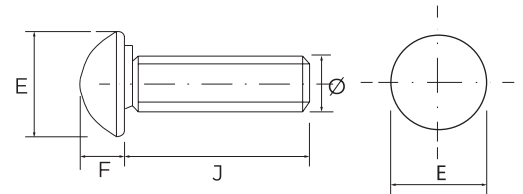

### Dimensões

Diâmetro	1/4"	5/16"	3/8"
E (máx)	14,50	17,70	20,90
F (máx)	3,80	4,60	5,40
passo (máx)	UNC-20	UNC-18	UNC-16

J	1/2"	5/8"	3/4"	1"	1.1/2"
	R\$ 79,93	R\$ 88,31	R\$ 92,64	R\$ 108,28	R\$ 140,26
		R\$ 145,83	R\$ 156,16	R\$ 165,38	R\$ 189,68
			R\$ 217,05	R\$ 241,34	R\$ 254,47
				R\$ 291,89	R\$ 366,74
				R\$ 248,33	R\$ 248,33

Preço de lista por cento

## Parafuso sextavado Recalcado métrica

Material: Aço baixo carbono  
Acabamento: Zincado

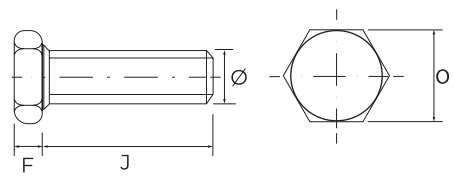

### Dimensões

Diâmetro	M5	M6	M8	M10	M12
O (máx.)	8,00	10,00	13,00	17,00	19,00
k (máx.)	3,55	4,05	5,35	6,45	7,55
Rosca - Fio	0,80	1,00	1,25	1,50	1,75

J	M5	M6	M8	M10	M12
10	R\$ 33,20	R\$ 46,14			
12	R\$ 35,56	R\$ 54,49			
16	R\$ 40,40	R\$ 56,43	R\$ 113,85	R\$ 208,32	
18	R\$ 38,32	R\$ 59,83			
20	R\$ 40,69	R\$ 68,18	R\$ 139,06	R\$ 227,76	R\$ 343,06
22		R\$ 66,62	R\$ 132,58	R\$ 237,44	
25	R\$ 46,76	R\$ 76,72	R\$ 154,70	R\$ 264,81	R\$ 366,79
30	R\$ 52,73	R\$ 80,30	R\$ 170,34	R\$ 289,09	R\$ 402,08
35	R\$ 63,65	R\$ 93,70	R\$ 185,88	R\$ 300,62	R\$ 437,38
40	R\$ 64,66	R\$ 97,28	R\$ 188,76	R\$ 337,66	R\$ 472,67
45		R\$ 105,82	R\$ 204,40	R\$ 349,19	R\$ 507,97
50		R\$ 114,36	R\$ 232,80	R\$ 373,47	R\$ 543,26
55		R\$ 122,91	R\$ 235,69	R\$ 397,86	R\$ 578,56
60		R\$ 131,34	R\$ 251,23	R\$ 422,15	R\$ 613,86
65			R\$ 266,87	R\$ 446,43	R\$ 649,05
70			R\$ 282,51	R\$ 483,48	R\$ 695,81
80			R\$ 313,79	R\$ 519,29	R\$ 754,94
90				R\$ 567,86	
100			R\$ 376,25	R\$ 616,53	R\$ 907,48

Preço de lista por cento

## Parafuso sextavado Recalcado rosca inteira

Material: Aço baixo carbono  
Acabamento: Zincado

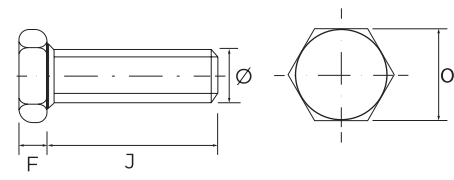

### Dimensões

Diâmetro	3/16"	1/4"	5/16"	3/8"	1/2"
O (máx.)	5/16"	7/16"	1/2"	9/16"	3/4"
Ø (máx.)	3,00	4,00	5,15	5,95	7,9
Rosca - Fio	BSW-24	UNC-20	UNC-18	UNC-16	UNC-13/BSW-12

J	3/16"	1/4"	5/16"	3/8"	1/2"
1/2"	R\$ 31,35	R\$ 55,31	R\$ 109,36	R\$ 153,30	
5/8"	R\$ 34,54	R\$ 69,01	R\$ 118,83	R\$ 167,09	
3/4"	R\$ 38,23	R\$ 74,75	R\$ 128,31	R\$ 180,88	R\$ 361,54
7/8"	R\$ 41,52	R\$ 80,52	R\$ 137,82	R\$ 194,63	R\$ 386,23
1"	R\$ 44,71	R\$ 81,04	R\$ 147,26	R\$ 208,46	R\$ 411,00
1.1/4"	R\$ 51,09	R\$ 97,76	R\$ 166,21	R\$ 236,04	R\$ 460,53
1.1/2"	R\$ 57,47	R\$ 109,26	R\$ 185,15	R\$ 263,61	R\$ 510,00
1.3/4"	R\$ 71,66	R\$ 128,56	R\$ 204,09	R\$ 291,15	R\$ 559,52
2"	R\$ 78,14	R\$ 140,06	R\$ 223,05	R\$ 318,77	R\$ 609,00
2.1/4"		R\$ 151,61	R\$ 241,96	R\$ 346,31	R\$ 658,51
2.1/2"		R\$ 163,07	R\$ 260,95	R\$ 373,92	R\$ 708,00
2.3/4"		R\$ 174,56	R\$ 279,93	R\$ 401,46	R\$ 757,51
3"		R\$ 186,09	R\$ 298,87	R\$ 429,04	R\$ 807,00
3.1/2"		R\$ 209,03	R\$ 336,74	R\$ 484,20	R\$ 906,00
4"		R\$ 232,08	R\$ 374,60	R\$ 539,35	R\$ 1.004,99
4.1/2"		R\$ 255,03	R\$ 412,58	R\$ 594,51	R\$ 1.103,98
5"		R\$ 278,08	R\$ 450,44	R\$ 649,66	R\$ 1.202,97

Preço de lista por cento

## Parafuso máquina Sextavado rosca inteira

Material: Aço baixo carbono  
Acabamento: Zincado ou Bicromatizado

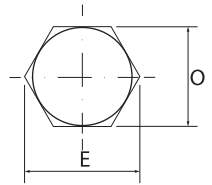
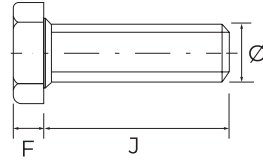

### Dimensões

Diâmetro	3/16"	1/4"	5/16"	3/8"
E (máx.)	5/16"	7/16"	1/2"	9/16"
O (máx.)	3,00	4,00	5,15	5,95
Rosca - Fio	BSW-24	UNC-20	UNC-18	UNC-16

J	1/2"	R\$ 33,92	R\$ 70,44	R\$ 121,46	R\$ 170,96
5/8"	R\$ 37,11	R\$ 76,20	R\$ 130,92	R\$ 184,74	
3/4"	R\$ 41,01	R\$ 81,96	R\$ 140,39	R\$ 198,53	
7/8"	R\$ 44,20	R\$ 87,72	R\$ 149,86	R\$ 212,32	
1"	R\$ 47,39	R\$ 93,49	R\$ 159,33	R\$ 197,23	
1.1/4"	R\$ 53,87	R\$ 104,91	R\$ 178,26	R\$ 253,69	
1.1/2"	R\$ 60,25	R\$ 124,24	R\$ 197,20	R\$ 281,27	
1.3/4"	R\$ 66,63	R\$ 135,76	R\$ 216,13	R\$ 308,85	
2"	R\$ 80,81	R\$ 147,29	R\$ 235,17	R\$ 336,42	
2.1/4"	R\$ 158,71	R\$ 254,10	R\$ 364,00		
2.1/2"	R\$ 170,24	R\$ 273,04	R\$ 391,58		
2.3/4"	R\$ 181,76	R\$ 291,97	R\$ 419,16		
3"	R\$ 193,29	R\$ 310,90	R\$ 446,74		
3.1/2"	R\$ 216,23	R\$ 348,77	R\$ 501,89		
4"	R\$ 239,28	R\$ 386,74	R\$ 557,05		
4.1/2"	R\$ 262,23	R\$ 424,61	R\$ 612,20		
5"	R\$ 285,28	R\$ 462,48	R\$ 667,36		

Preço de lista por cento

## Parafuso máquina Sextavado rosca métrica

Material: Aço baixo carbono  
Acabamento: Zincado ou Bicromatizado

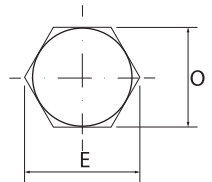
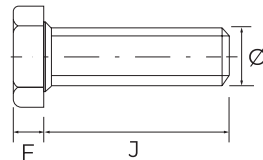

### Dimensões

Diâmetro	M5	M6	M8	M10	M12
O (máx.)	8,00	10,00	13,00	17,00	19,00
k (máx.)	3,55	4,05	5,35	6,45	7,55
Rosca - Fio	0,80	1,00	1,25	1,50	1,75

J	10	R\$ 36,49	R\$ 56,96		
12	R\$ 38,85	R\$ 60,45			
16		R\$ 67,25	R\$ 139,67	R\$ 248,13	
18	R\$ 46,56	R\$ 70,64			
20	R\$ 48,93	R\$ 74,04	R\$ 152,23	R\$ 267,58	R\$ 382,64
22		R\$ 77,43	R\$ 158,40	R\$ 277,36	
25	R\$ 55,00	R\$ 82,58	R\$ 167,87	R\$ 291,87	R\$ 417,93
30	R\$ 60,97	R\$ 91,12	R\$ 183,41	R\$ 316,15	R\$ 453,20
35	R\$ 66,94	R\$ 99,66	R\$ 199,05	R\$ 340,44	R\$ 488,49
40	R\$ 72,91	R\$ 108,10	R\$ 201,52	R\$ 364,83	R\$ 523,78
45		R\$ 124,44	R\$ 230,33	R\$ 389,11	R\$ 559,05
50		R\$ 132,98	R\$ 245,97	R\$ 413,40	R\$ 594,34
55		R\$ 141,53	R\$ 261,51	R\$ 437,68	R\$ 629,62
60		R\$ 150,07	R\$ 277,15	R\$ 461,97	R\$ 664,91
65			R\$ 292,79	R\$ 486,25	R\$ 700,18
70			R\$ 308,43	R\$ 510,54	R\$ 735,47
80			R\$ 339,61	R\$ 559,21	R\$ 806,03
90				R\$ 607,78	
100			R\$ 402,18	R\$ 656,35	R\$ 947,16

Preço de lista por cento

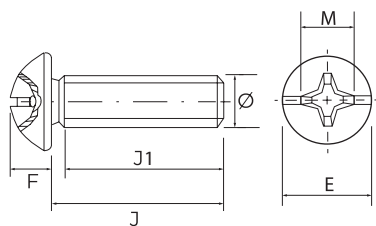

### Parafuso máquina Lentilha combinada

Material: Aço baixo carbono  
Acabamento: Zincado ou Bicromatizado

#### Dimensões

Diâmetro	1/4"	5/16"
E (máx.)	14,50	17,70
F (máx.)	3,80	4,60
M (ref.)	3	4
Rosca - fio	UNC-20	UNC-18
J1 (min.)	50,00	50,00

<b>J</b>	90	R\$ 217,47	
	100	R\$ 233,52	R\$ 363,38
	110	R\$ 240,00	R\$ 393,02
	120	R\$ 266,45	R\$ 422,04

Preço de lista por cento

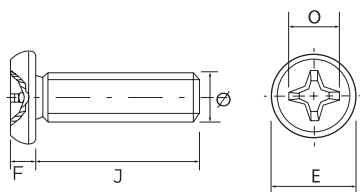

### Parafuso máquina Tampinha 13 phillips

Material: Aço baixo carbono  
Acabamento: Zincado ou Bicromatizado

<b>J</b>	Diâmetro	1/4"
	40	R\$ 102,60
	50	R\$ 128,06
	60	R\$ 147,74
	70	R\$ 172,21
	80	R\$ 188,16
	90	R\$ 207,31
	100	R\$ 225,18
	110	R\$ 246,34
	120	R\$ 269,53
	130	R\$ 290,06
140	R\$ 311,33	
150	R\$ 332,07	

Preço de lista por cento

Diâmetro	1/4"
3/4"	R\$ 63,35
1"	R\$ 72,93
1.1/4"	R\$ 85,69
1.1/2"	R\$ 102,50
2"	R\$ 127,96

Preço de lista por cento

## Parafuso máquina Tampinha estrutural Allen

Material: Aço baixo carbono  
Acabamento: Zincado ou Bicromatizado

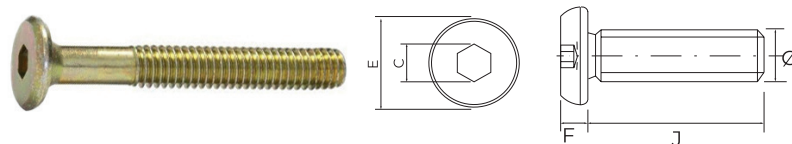

### Dimensões

Diâmetro	1/4"	
J	40	R\$ 89,47
	50	R\$ 112,73
	60	R\$ 124,31
	70	R\$ 151,58
	80	R\$ 169,37
	90	R\$ 179,12
	100	R\$ 198,21
	110	R\$ 216,84
	120	R\$ 237,25
	130	R\$ 255,32
	140	R\$ 274,05
	150	R\$ 292,30

Preço de lista por cento

## Parafuso máquina Tampinha 13 Phillips e Estrutural Tampinha 13 Allen

Material: Aço baixo carbono  
Acabamento: Zincado ou Bicromatizado

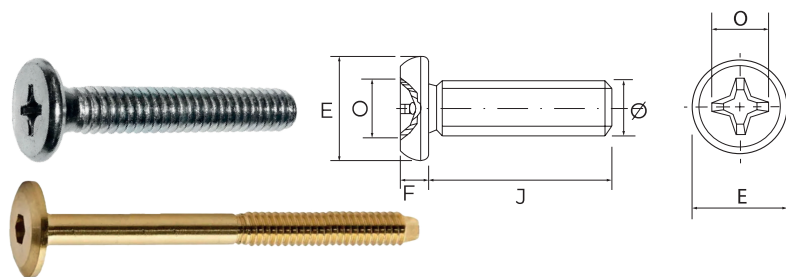

Tampinha 13 Phillips

		1/4"
J	40	R\$ 99,45
	50	R\$ 124,34
	60	R\$ 143,38
	70	R\$ 167,05
	80	R\$ 182,48
	90	R\$ 201,00
	100	R\$ 218,29
	110	R\$ 238,77
	120	R\$ 261,20
	130	R\$ 281,06
	140	R\$ 301,64
	150	R\$ 321,71

Preço de lista por cento

Estrutural Tampinha 13 Allen

		1/4"
J	40	R\$ 86,73
	50	R\$ 109,45
	60	R\$ 124,31
	70	R\$ 147,04
	80	R\$ 164,25
	90	R\$ 179,12
	100	R\$ 192,15
	110	R\$ 210,17
	120	R\$ 229,92
	130	R\$ 247,40
	140	R\$ 265,52
	150	R\$ 283,18

Preço de lista por cento

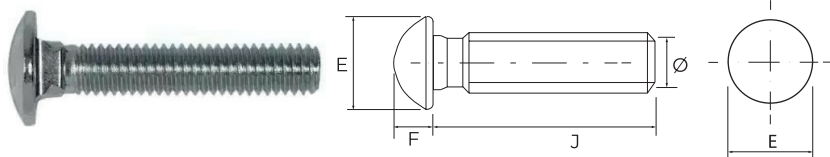

### Parafuso máquina Francês sem porca

Material: Aço baixo carbono  
Acabamento: Zincado ou Bicromatizado

#### Dimensões

Diâmetro	1/4"	5/16"	3/8"
E (máx)	15,09	18,26	21,44
F (máx)	3,68	4,47	5,28
S (máx)	6,60	8,23	9,85

J	3/4"	R\$ 75,27	R\$ 134,12	
1"	R\$ 89,47	R\$ 156,55	R\$ 233,83	
1.1/4"	R\$ 99,97	R\$ 179,39	R\$ 266,86	
1.1/2"	R\$ 110,88	R\$ 193,08	R\$ 293,62	
1.3/4"	R\$ 127,94	R\$ 216,44	R\$ 318,72	
2"	R\$ 143,69	R\$ 233,73	R\$ 343,83	
2.1/4"	R\$ 159,43	R\$ 248,03	R\$ 365,65	
2.1/2"	R\$ 166,53	R\$ 269,74	R\$ 402,28	
2.3/4"	R\$ 171,98	R\$ 286,31	R\$ 428,73	
3"	R\$ 190,30	R\$ 310,90	R\$ 456,20	
3.1/2"	R\$ 214,07	R\$ 347,13	R\$ 513,11	
4"	R\$ 236,92	R\$ 388,29	R\$ 564,56	
4.1/2"	R\$ 255,75	R\$ 427,39	R\$ 639,68	
5"	R\$ 283,33	R\$ 461,35	R\$ 676,72	
5.1/2"		R\$ 500,45	R\$ 738,47	
6"		R\$ 538,53	R\$ 790,12	
6.1/2"		R\$ 573,51	R\$ 847,54	
7"		R\$ 610,56	R\$ 906,20	

Preço de lista por cento

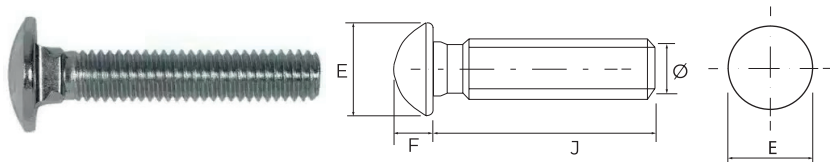

### Parafuso máquina Francês sem porca

Material: Aço baixo carbono  
Acabamento: Zincado

#### Dimensões

Diâmetro	M5	M6	M8	M10	M12	M16	M20
E (máx)	13,50	16,55	20,65	24,65	30,65	38,80	46,80
F (máx)	3,30	3,88	4,88	5,38	6,95	8,95	11,05
S (máx)	5,48	6,48	8,58	10,58	12,70	16,70	20,84

J	16	R\$ 45,42	R\$ 74,48				
20	R\$ 50,43	R\$ 81,50	R\$ 151,43	R\$ 240,63			
25	R\$ 56,44	R\$ 90,52	R\$ 167,47	R\$ 265,68			
30	R\$ 64,46	R\$ 101,54	R\$ 183,50	R\$ 290,73	R\$ 469,83		
35	R\$ 72,48	R\$ 120,37	R\$ 203,55	R\$ 315,79	R\$ 506,91		
40	R\$ 88,30	R\$ 131,39	R\$ 223,59	R\$ 340,84	R\$ 543,99		
45	R\$ 96,32	R\$ 142,41	R\$ 243,63	R\$ 371,91	R\$ 581,07		
50	R\$ 104,33	R\$ 153,44	R\$ 263,68	R\$ 402,98	R\$ 625,16	R\$ 1.204,41	
55	R\$ 112,35	R\$ 164,46	R\$ 282,72	R\$ 434,04	R\$ 669,26	R\$ 1.274,56	
60	R\$ 120,37	R\$ 175,49	R\$ 302,76	R\$ 465,11	R\$ 713,35	R\$ 1.344,71	
65	R\$ 128,38	R\$ 186,51	R\$ 322,80	R\$ 496,18	R\$ 757,45	R\$ 1.424,88	
70	R\$ 136,40	R\$ 197,53	R\$ 342,85	R\$ 527,24	R\$ 801,54	R\$ 1.505,06	R\$ 2.487,17
80	R\$ 152,44	R\$ 219,58	R\$ 381,93	R\$ 589,38	R\$ 883,72	R\$ 1.665,40	R\$ 2.737,71
90		R\$ 241,63	R\$ 422,02	R\$ 651,51	R\$ 973,91	R\$ 1.825,75	R\$ 2.988,25
100		R\$ 263,68	R\$ 462,10	R\$ 713,64	R\$ 1.064,11	R\$ 1.986,09	R\$ 3.238,79
110		R\$ 285,72	R\$ 502,19	R\$ 775,78	R\$ 1.154,30	R\$ 2.146,44	R\$ 3.489,32
120		R\$ 307,77	R\$ 542,27	R\$ 837,91	R\$ 1.244,49	R\$ 2.306,78	R\$ 3.739,86
130		R\$ 329,82	R\$ 582,36	R\$ 900,04	R\$ 1.334,69	R\$ 2.467,12	R\$ 3.990,40
140		R\$ 341,84	R\$ 622,45	R\$ 965,18	R\$ 1.424,88	R\$ 2.627,47	R\$ 4.240,94
150		R\$ 362,60	R\$ 661,24	R\$ 1.024,02	R\$ 1.515,08	R\$ 2.787,81	R\$ 4.491,48
160				R\$ 1.084,15	R\$ 1.605,27	R\$ 2.948,16	R\$ 4.992,56
180				R\$ 1.204,41	R\$ 1.785,66	R\$ 3.268,85	R\$ 5.493,64
200				R\$ 1.324,67	R\$ 1.966,05	R\$ 3.589,54	R\$ 5.994,71

Preço de lista por cento

Consulte a disponibilidade

## Barra Roscada

Material: Aço baixo carbono  
Acabamento: Zincado, Bicromatizado ou Polido



### Dimensões

K	Polido		Zincado		Fios P.P.
	1m	3m	1m	3m	
3/16"	R\$ 8,19		R\$ 9,82		UNC-24
1/4"	R\$ 14,34	R\$ 42,83	R\$ 17,21	R\$ 51,45	UNC-20
5/16"	R\$ 23,56	R\$ 70,50	R\$ 28,30	R\$ 84,71	UNC-18
3/8"	R\$ 34,25	R\$ 102,57	R\$ 41,14	R\$ 123,24	UNC-16
1/2"	R\$ 182,20	R\$ 60,80	R\$ 218,93	R\$ 73,04	BSW-12
1/2"	R\$ 182,20	R\$ 60,80	R\$ 218,93	R\$ 73,04	UNC-13
5/8"	R\$ 101,26	R\$ 303,60	R\$ 121,67	R\$ 364,83	UNC-11
3/4"	R\$ 453,42	R\$ 151,20	R\$ 544,86	R\$ 181,68	UNC-10
7/8"	R\$ 202,43	R\$ 607,11	R\$ 243,25	R\$ 729,56	UNC-9
1"	R\$ 267,18	R\$ 801,36	R\$ 321,06	R\$ 962,99	UNC-8

Preço de lista por cento

## Barra Roscada métrica

Material: Aço baixo carbono  
Acabamento: Zincado, Bicromatizado ou Polido

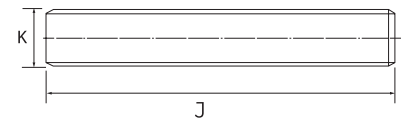

### Dimensões

K	Polido 1m	Zincado 1m	Passo
	M5	R\$ 0,18	R\$ 0,19
M6	R\$ 0,19	R\$ 0,21	1,00
M8	R\$ 0,26	R\$ 0,29	1,25
M10	R\$ 0,36	R\$ 0,41	1,50
M12	R\$ 0,48	R\$ 0,56	1,75
M14	R\$ 0,62	R\$ 0,73	2,00
M16	R\$ 0,82	R\$ 0,96	2,00
M18	R\$ 0,99	R\$ 1,17	2,50
M20	R\$ 1,23	R\$ 1,46	2,50
M22	R\$ 1,53	R\$ 1,82	2,50
M24	R\$ 1,76	R\$ 2,09	3,00

Preço de lista por unidade



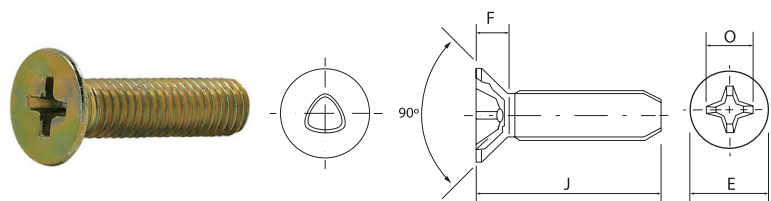

## Parafuso trilobular Chata phillips métrico

Material: Aço baixo carbono  
Acabamento: Zincado ou Bicromatizado

### Dimensões

Diâmetro	M2,5	M3	M3,5	M4	M5	M6	M8
E (máx)	4,70	5,60	6,50	7,50	9,20	11,00	14,50
F (ref.)	1,50	1,65	1,93	2,20	2,50	3,00	4,00
O (ref.)	2,70	2,90	3,90	4,40	4,60	6,60	8,70

J	4	6	8	10	12	16	18	20	25	30	35	40	45	50
	R\$ 7,78	R\$ 8,98												
	R\$ 8,68	R\$ 10,33	R\$ 12,67	R\$ 15,59										
	R\$ 9,58	R\$ 11,69	R\$ 14,42	R\$ 17,79	R\$ 25,45									
	R\$ 10,49	R\$ 12,89	R\$ 16,18	R\$ 20,12	R\$ 29,00	R\$ 41,45	R\$ 84,66							
	R\$ 11,39	R\$ 14,24	R\$ 17,93	R\$ 22,46	R\$ 32,56	R\$ 46,43	R\$ 93,77							
	R\$ 13,19	R\$ 16,94	R\$ 21,44	R\$ 27,00	R\$ 39,52	R\$ 56,67	R\$ 111,83							
	R\$ 14,09	R\$ 18,29	R\$ 23,19	R\$ 29,19	R\$ 43,08	R\$ 61,50	R\$ 120,78							
	R\$ 14,99	R\$ 19,65	R\$ 24,95	R\$ 31,53	R\$ 46,63	R\$ 66,62	R\$ 129,89							
		R\$ 22,95	R\$ 29,33	R\$ 37,08	R\$ 55,31	R\$ 79,14	R\$ 152,35							
			R\$ 33,72	R\$ 42,78	R\$ 63,98	R\$ 91,79	R\$ 179,51							
					R\$ 72,52	R\$ 104,31	R\$ 198,00							
					R\$ 85,87	R\$ 123,22	R\$ 232,67							
						R\$ 136,60	R\$ 256,73							
						R\$ 157,64	R\$ 280,79							

Preço de lista por cento

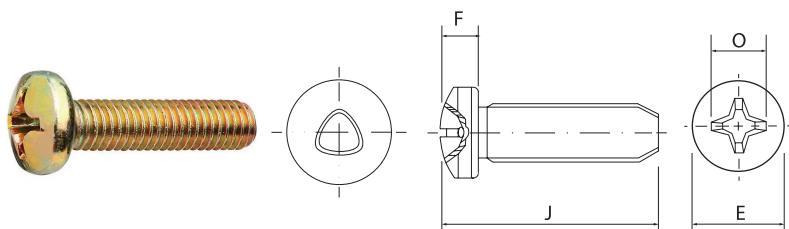

## Parafuso trilobular Chata phillips métrico

Material: Aço baixo carbono  
Acabamento: Zincado ou Bicromatizado

### Dimensões

Diâmetro	M2,5	M3	M3,5	M4	M5	M6	M8
E (máx)	5,00	6,00	7,00	8,00	10,00	12,00	16,00
F (máx)	2,12	2,52	2,82	3,25	3,95	4,75	6,15
O (ref.)	2,70	3,10	4,20	4,60	5,30	6,80	9,00

J	4	6	8	10	12	16	18	20	25	30	35	40	45	50
	R\$ 10,18	R\$ 13,94												
	R\$ 11,09	R\$ 15,29	R\$ 19,98	R\$ 26,26	R\$ 42,65									
	R\$ 12,89	R\$ 16,64	R\$ 21,73	R\$ 28,46	R\$ 46,21									
	R\$ 13,79	R\$ 17,84	R\$ 23,49	R\$ 30,80	R\$ 49,76	R\$ 78,43	R\$ 168,14							
	R\$ 15,59	R\$ 18,90	R\$ 25,39	R\$ 32,99	R\$ 53,32	R\$ 83,40	R\$ 176,67							
	R\$ 16,49	R\$ 21,30	R\$ 29,04	R\$ 37,52	R\$ 60,93	R\$ 80,56	R\$ 195,16							
	R\$ 17,39	R\$ 22,50	R\$ 30,94	R\$ 39,86	R\$ 64,49	R\$ 85,54	R\$ 205,11							
	R\$ 19,65	R\$ 23,70	R\$ 33,40	R\$ 42,76	R\$ 68,04	R\$ 90,65	R\$ 215,07							
	R\$ 22,35	R\$ 27,41	R\$ 38,23	R\$ 48,31	R\$ 76,86	R\$ 103,03	R\$ 237,82							
		R\$ 31,01	R\$ 43,78	R\$ 55,62	R\$ 86,39	R\$ 115,54	R\$ 261,99							
			R\$ 55,04	R\$ 62,93	R\$ 97,76	R\$ 127,63	R\$ 284,74							
				R\$ 81,67	R\$ 122,90	R\$ 155,98	R\$ 324,40							
					R\$ 133,43	R\$ 169,52	R\$ 348,45							
					R\$ 143,96	R\$ 183,05	R\$ 372,51							

Preço de lista por cento

## Parafuso Trilobular Sextavada Flangeada Métrica

Material: Aço baixo carbono  
Acabamento: Zincado

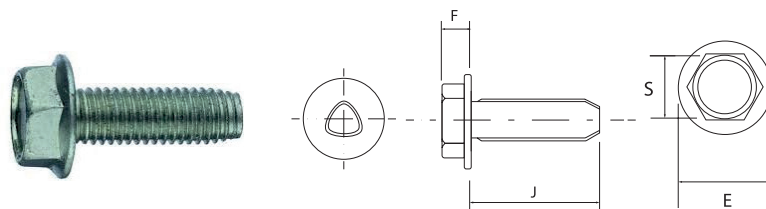

### Dimensões

Diâmetro	M5	M6	M8
E (máx)	11,80	14,20	18,00
F (máx)	5,40	6,60	8,10
S (máx)	8,00	10,00	13,00

J				
10		R\$ 59,37		
12		R\$ 62,93	R\$ 101,32	
16		R\$ 70,04	R\$ 111,27	R\$ 225,02
20		R\$ 78,57	R\$ 122,65	R\$ 243,51
25		R\$ 89,23	R\$ 138,29	R\$ 269,10
30		R\$ 100,61	R\$ 162,45	R\$ 297,54
35		R\$ 119,08	R\$ 178,09	R\$ 324,56
40		R\$ 136,44	R\$ 204,10	R\$ 372,51
45		R\$ 148,47	R\$ 220,64	R\$ 402,59
50		R\$ 159,74	R\$ 237,18	R\$ 432,66

Preço de lista por cento

## Haste de ferro Prisioneiro

Material: Aço baixo carbono  
Acabamento: Zincado

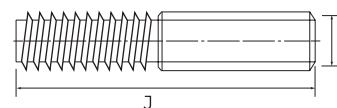

### Dimensões

Diâmetro K	1/4"	5/16"
------------	------	-------

J			
45		R\$ 0,82	R\$ 1,39
55		R\$ 0,96	R\$ 1,68
70		R\$ 1,33	R\$ 2,10
90		R\$ 1,67	R\$ 2,67

Preço de lista por unidade

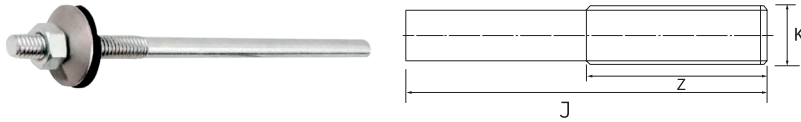

### Kit haste

Para telha com conjunto de vedação

Material: Aço baixo carbono  
Acabamento: Zincado

#### Dimensões

Diâmetro	1/4"
Z (ref.)	50

J		
150	R\$	279,70
200	R\$	342,32
250	R\$	404,94
300	R\$	467,56
350	R\$	530,18
400	R\$	592,80
450	R\$	655,42
500	R\$	718,0

Preço de lista por cento

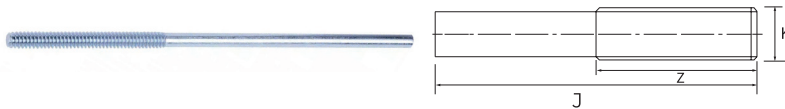

### Haste rosca

Para telha

Material: Aço baixo carbono  
Acabamento: Zincado

#### Dimensões

Diâmetro	1/4"
Z (ref.)	50

J		
150	R\$	279,70
200	R\$	342,32
250	R\$	404,94
300	R\$	467,56
350	R\$	530,18
400	R\$	592,80
450	R\$	655,42
500	R\$	718,0

Preço de lista por cento

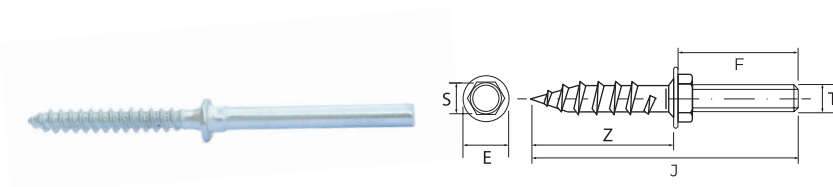

### Parafuso Suporte

Invisível

Material: Aço baixo carbono  
Acabamento: Zincado

#### Dimensões

Diâmetro K	1/4"
S (ref.)	6,4
T (ref.)	5,4

J		
95	R\$	111,30
150	R\$	176,67
200	R\$	232,02

Preço de lista por cento

## Cabeça Cilíndrica Sextavado Interno - série polegada ASMEB 18.3

Material: Aço baixo carbono  
Acabamento: Oxidado térmico

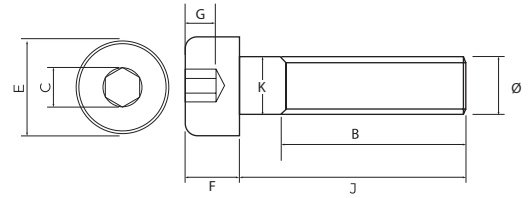

### Dimensões

Diâmetro	1/4"	5/16"	3/8"	1/2"	5/8"	3/4"	7/8"	1"
E (máx)	9,53	11,91	14,27	19,05	23,83	28,58	33,32	38,10
F (máx)	6,35	7,92	9,53	12,70	15,88	19,05	22,23	25,40
G (máx)	3,05	3,84	4,62	6,22	7,80	9,40	10,97	12,57
C (ref.)	3/16"	1/4"	5/16"	3/8"	1/2"	5/8"	3/4"	3/4"
B (ref.)	1"	1.1/8"	1.1/4"	1.1/2"	1.3/4"	2"	2.1/4"	2.1/2"

<b>J</b>	1/2"	R\$ 53,82	R\$ 99,96	R\$ 152,90					
	5/8"	R\$ 58,76	R\$ 108,09	R\$ 164,90					
	3/4"	R\$ 63,70	R\$ 116,22	R\$ 177,00	R\$ 372,67				
	7/8"	R\$ 68,63	R\$ 124,35	R\$ 189,10	R\$ 394,74				
	1"	R\$ 73,57	R\$ 132,57	R\$ 201,10	R\$ 416,81	R\$ 727,12	R\$ 1.157,45		
	1.1/4"	R\$ 88,86	R\$ 148,84	R\$ 225,30	R\$ 460,95	R\$ 797,58	R\$ 1.261,20		
	1.1/2"	R\$ 111,96	R\$ 176,52	R\$ 259,66	R\$ 505,18	R\$ 868,04	R\$ 1.364,96	R\$ 2.013,55	R\$ 2.966,93
	1.3/4"	R\$ 127,25	R\$ 200,42	R\$ 294,02	R\$ 566,25	R\$ 938,41	R\$ 1.468,72	R\$ 2.157,38	R\$ 3.155,57
	2"	R\$ 142,54	R\$ 224,23	R\$ 328,38	R\$ 627,33	R\$ 1.033,94	R\$ 1.572,38	R\$ 2.301,11	R\$ 3.344,22
	2.1/4"	R\$ 157,84	R\$ 248,14	R\$ 362,74	R\$ 688,50	R\$ 1.129,47	R\$ 1.709,92	R\$ 2.444,94	R\$ 3.532,86
	2.1/2"	R\$ 173,13	R\$ 271,95	R\$ 397,10	R\$ 749,57	R\$ 1.224,91	R\$ 1.847,46	R\$ 2.632,04	R\$ 3.721,50
	2.3/4"	R\$ 188,33	R\$ 295,86	R\$ 431,56	R\$ 810,74	R\$ 1.320,44	R\$ 1.984,90	R\$ 2.819,23	R\$ 3.965,90
	3"	R\$ 203,62	R\$ 319,77	R\$ 465,92	R\$ 871,82	R\$ 1.415,87	R\$ 2.122,44	R\$ 3.006,42	R\$ 4.210,39
	3.1/2"		R\$ 357,90	R\$ 520,90	R\$ 969,58	R\$ 1.568,70	R\$ 2.342,44	R\$ 3.305,89	R\$ 4.601,51

Preço de lista por cento      Consulte a disponibilidade

## Cabeça Cilíndrica Baixa Sextavado Interno série métrica DIN 7984

Material: Aço baixo carbono  
Acabamento: Oxidado térmico

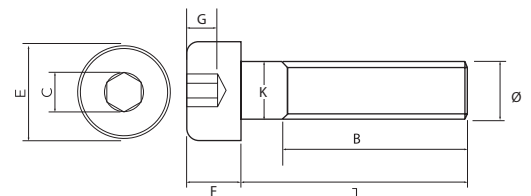

### Dimensões

Diâmetro	M3	M4	M5	M6	M8	M10	M12	M14	M16	M18	M20	M22	M24
E (máx)	5,50	7,00	8,50	10,00	13,00	16,00	18,00	21,00	24,00	27,00	30,00	33,00	36,00
F (máx)	2,00	2,80	3,50	4,00	5,00	6,00	7,00	8,00	9,00	10,00	11,00	12,00	13,00
G (máx)	1,62	2,42	2,82	3,12	3,95	4,65	5,15	5,45	5,65	6,68	7,68	8,18	8,18
S (ref.)	2	3	3	4	5	7	8	10	12	12	14	14	17
B (ref.)	12	14	16	18	22	26	30	34	38	42	46	50	54

<b>J</b>	5	R\$ 9,92											
	6	R\$ 10,35	R\$ 16,54										
	8	R\$ 11,22	R\$ 18,01										
	10	R\$ 12,09	R\$ 19,47	R\$ 29,06	R\$ 42,11								
	12	R\$ 12,96	R\$ 20,93	R\$ 31,28	R\$ 45,31								
	16	R\$ 14,80	R\$ 23,85	R\$ 35,83	R\$ 51,70	R\$ 104,31	R\$ 161,19						
	20	R\$ 17,10	R\$ 26,78	R\$ 42,11	R\$ 58,08	R\$ 116,02	R\$ 179,48	R\$ 257,59					
	25		R\$ 31,95	R\$ 49,57	R\$ 78,89	R\$ 138,96	R\$ 202,32	R\$ 290,79					
	30			R\$ 56,34	R\$ 78,51	R\$ 154,45	R\$ 225,17	R\$ 323,89	R\$ 461,91	R\$ 612,91			
	35				R\$ 89,25	R\$ 174,78	R\$ 253,82	R\$ 357,09	R\$ 509,34	R\$ 677,76			
	40					R\$ 187,36	R\$ 282,66	R\$ 397,84	R\$ 556,77	R\$ 742,60	R\$ 970,06	R\$ 1.270,11	
	45						R\$ 218,33	R\$ 311,60	R\$ 438,88	R\$ 614,84	R\$ 807,45	R\$ 1.047,49	R\$ 1.366,90
	50						R\$ 226,07	R\$ 347,32	R\$ 480,01	R\$ 672,92	R\$ 879,08	R\$ 1.124,92	R\$ 1.463,69
	55						R\$ 245,43	R\$ 376,84	R\$ 521,44	R\$ 730,99	R\$ 950,70	R\$ 1.221,71	R\$ 1.560,48
	60						R\$ 264,79	R\$ 406,55	R\$ 571,58	R\$ 789,06	R\$ 1.018,46	R\$ 1.318,50	R\$ 1.676,63
	70							R\$ 460,60	R\$ 655,88	R\$ 906,18	R\$ 1.163,64	R\$ 1.512,08	R\$ 1.918,60
	80								R\$ 740,86	R\$ 1.028,13	R\$ 1.308,82	R\$ 1.705,66	R\$ 2.160,57
	90											R\$ 1.899,24	R\$ 2.402,55
												R\$ 2.954,25	R\$ 3.486,59

Preço de lista por cento      Consulte a disponibilidade

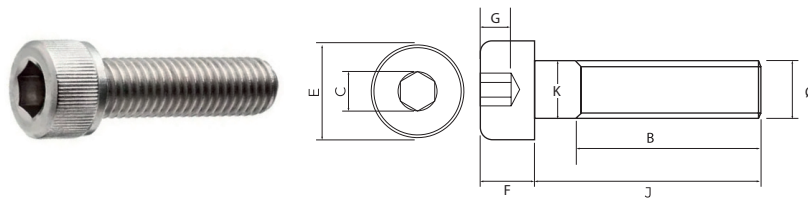

## Cabeça Cilindrica Baixa

Sextavado Interno  
série métrica DIN 912

Material: Aço baixo carbono  
Acabamento: Zincado

### Dimensões

Diâmetro	M2	M2,5	M3	M4	M5	M6	M8	M10	M12	M14	M16	M18	M20
E (máx)	3,98	4,68	5,68	7,22	8,72	10,22	13,27	16,27	18,27	21,33	24,33	27,33	30,33
F (máx)	2,00	2,50	3,00	4,00	5,00	6,00	8,00	10,00	12,00	14,00	16,00	18,00	20,00
G (máx)	1,00	1,10	1,30	2,00	2,50	3,00	4,00	5,00	6,00	7,00	8,00	9,00	10,00
C (ref.)	2	2	3	3	4	5	6	8	10	12	14	14	17
B (ref.)	16	17	18	20	22	24	28	32	36	40	44	48	52

J	M2	M2,5	M3	M4	M5	M6	M8	M10	M12	M14	M16	M18	M20	
4	R\$ 6,60	R\$ 8,19												
5	R\$ 6,83	R\$ 8,51	R\$ 11,65											
6	R\$ 7,06	R\$ 8,82	R\$ 12,07	R\$ 19,75										
8	R\$ 7,52	R\$ 9,45	R\$ 13,01	R\$ 21,26	R\$ 29,05									
10	R\$ 7,98	R\$ 10,08	R\$ 13,85	R\$ 22,77	R\$ 31,47	R\$ 50,82								
12	R\$ 8,68	R\$ 10,71	R\$ 14,69	R\$ 24,29	R\$ 33,89	R\$ 54,41	R\$ 118,64							
16	R\$ 9,37	R\$ 11,97	R\$ 16,79	R\$ 27,31	R\$ 38,73	R\$ 60,99	R\$ 130,25	R\$ 215,43						
20	R\$ 10,30	R\$ 13,22	R\$ 19,59	R\$ 32,05	R\$ 44,15	R\$ 68,54	R\$ 142,83	R\$ 234,78	R\$ 322,54					
25		R\$ 15,50	R\$ 22,21	R\$ 37,09	R\$ 51,60	R\$ 78,80	R\$ 158,32	R\$ 258,98	R\$ 357,38	R\$ 476,43	R\$ 701,95			
30			R\$ 24,83	R\$ 42,13	R\$ 59,05	R\$ 85,67	R\$ 176,71	R\$ 283,18	R\$ 392,23	R\$ 524,83	R\$ 764,87	R\$ 1.086,21	R\$ 1.250,75	
35				R\$ 47,17	R\$ 66,50	R\$ 101,25	R\$ 196,07	R\$ 307,38	R\$ 427,07	R\$ 573,22	R\$ 828,75	R\$ 1.173,32	R\$ 1.357,22	
40					R\$ 60,01	R\$ 81,76	R\$ 119,61	R\$ 215,43	R\$ 331,57	R\$ 461,91	R\$ 621,62	R\$ 892,63	R\$ 1.260,43	R\$ 1.463,69
45						R\$ 89,21	R\$ 130,25	R\$ 234,78	R\$ 362,55	R\$ 496,76	R\$ 670,01	R\$ 956,51	R\$ 1.347,54	R\$ 1.570,16
50						R\$ 96,67	R\$ 140,90	R\$ 254,14	R\$ 393,52	R\$ 539,35	R\$ 718,41	R\$ 1.037,81	R\$ 1.434,65	R\$ 1.676,63
55							R\$ 151,55	R\$ 273,50	R\$ 424,49	R\$ 581,93	R\$ 766,80	R\$ 1.115,25	R\$ 1.521,76	R\$ 1.783,09
60							R\$ 162,19	R\$ 292,86	R\$ 455,47	R\$ 625,49	R\$ 824,88	R\$ 1.192,68	R\$ 1.608,87	R\$ 1.889,56
65								R\$ 313,18	R\$ 486,44	R\$ 668,08	R\$ 882,95	R\$ 1.270,11	R\$ 1.695,98	R\$ 1.996,03
70								R\$ 332,54	R\$ 517,41	R\$ 701,95	R\$ 941,02	R\$ 1.347,54	R\$ 1.783,09	R\$ 2.102,50
80								R\$ 371,26	R\$ 579,36	R\$ 788,10	R\$ 1.057,17	R\$ 1.502,40	R\$ 1.976,67	R\$ 2.344,47
90									R\$ 641,30	R\$ 874,24	R\$ 1.173,32	R\$ 1.657,27	R\$ 2.170,25	R\$ 2.586,45
100									R\$ 702,28	R\$ 960,38	R\$ 1.289,47	R\$ 1.812,13	R\$ 2.363,83	R\$ 2.828,42
110										R\$ 1.047,49	R\$ 1.405,61	R\$ 1.966,99	R\$ 2.557,41	R\$ 3.070,40
120										R\$ 1.134,60	R\$ 1.521,76	R\$ 2.121,86	R\$ 2.750,99	R\$ 3.312,37
130											R\$ 1.637,91	R\$ 2.276,72	R\$ 2.944,57	R\$ 3.554,35
140											R\$ 1.754,06	R\$ 2.431,59	R\$ 3.138,15	R\$ 3.796,32
150												R\$ 2.586,45	R\$ 3.331,73	R\$ 4.038,29
160												R\$ 2.741,31	R\$ 3.525,31	R\$ 4.280,27
180													R\$ 3.912,47	R\$ 4.764,22
200														R\$ 5.248,17

Preço de lista por cento ■ Consulte a disponibilidade

## Cabeça Cilíndrica Baixa

Sextavado Interno  
série métrica DIN 7984

Material: Aço baixo carbono  
Acabamento: Zincado

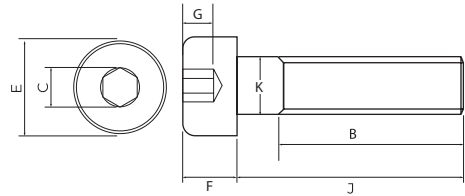

### Dimensões

Diâmetro	M3	M4	M5	M6	M8	M10	M12	M14	M16	M18	M20
E (máx)	5,50	7,00	8,50	10,00	13,00	16,00	18,00	21,00	24,00	27,00	30,00
F (máx)	2,00	2,80	3,50	4,00	5,00	6,00	7,00	8,00	9,00	10,00	11,00
G (máx)	1,62	2,42	2,82	3,12	3,95	4,65	5,15	5,45	5,65	6,68	7,68
C (ref.)	2	3	3	4	5	7	8	10	12	12	14
B (ref.)	12	14	16	18	22	26	30	34	38	42	46

J	5	6	8	10	12	16	20	25	30	35	40	45	50	55	60	70	80	90
	R\$ 9,92																	
	R\$ 10,35	R\$ 16,54																
	R\$ 11,22	R\$ 18,01																
	R\$ 12,09	R\$ 19,47	R\$ 29,06	R\$ 42,11														
	R\$ 12,96	R\$ 20,93	R\$ 31,28	R\$ 45,31														
	R\$ 14,80	R\$ 23,85	R\$ 35,83	R\$ 51,70	R\$ 104,31	R\$ 161,19												
	R\$ 17,10	R\$ 26,78	R\$ 42,11	R\$ 58,08	R\$ 116,02	R\$ 179,48	R\$ 257,59											
		R\$ 31,95	R\$ 49,57	R\$ 78,89	R\$ 138,96	R\$ 202,32	R\$ 290,79											
			R\$ 56,34	R\$ 78,51	R\$ 154,45	R\$ 225,17	R\$ 323,89	R\$ 461,91	R\$ 612,91									
				R\$ 89,25	R\$ 174,78	R\$ 253,82	R\$ 357,09	R\$ 509,34	R\$ 677,76									
				R\$ 100,57	R\$ 187,36	R\$ 282,66	R\$ 397,84	R\$ 556,77	R\$ 742,60	R\$ 970,06	R\$ 1.270,11							
				R\$ 218,33	R\$ 311,60	R\$ 438,88	R\$ 614,84	R\$ 807,45	R\$ 1.047,49	R\$ 1.366,90								
				R\$ 226,07	R\$ 347,32	R\$ 480,01	R\$ 672,92	R\$ 879,08	R\$ 1.124,92	R\$ 1.463,69								
				R\$ 245,43	R\$ 376,84	R\$ 521,44	R\$ 730,99	R\$ 950,70	R\$ 1.221,71	R\$ 1.560,48								
				R\$ 264,79	R\$ 406,55	R\$ 571,58	R\$ 789,06	R\$ 1.018,46	R\$ 1.318,50	R\$ 1.676,63								
				R\$ 460,60	R\$ 655,88	R\$ 906,18	R\$ 1.163,64	R\$ 1.512,08	R\$ 1.918,60									
				R\$ 740,86	R\$ 1.028,13	R\$ 1.308,82	R\$ 1.705,66	R\$ 2.160,57	R\$ 2.705,66	R\$ 3.402,55								

Preço de lista por cento

Consulte a disponibilidade



# Parafuso Telha

Fixação segura para sua cobertura:  
conheça nossos parafusos para telhas.

Nosso parafuso para fixação de telhas de fibrocimento, como eternit, brasilit, entre outras, oferece segurança e praticidade na instalação. Com cabeça sextavada, pode ser facilmente fixado com chave número 11. Além disso, acompanha arruela de metal e arruela de borracha, que garantem uma vedação eficiente, evitando a entrada de água e outros elementos indesejados na cobertura. Com nosso parafuso, você tem a certeza de uma fixação segura e duradoura, sem comprometer a estética e a integridade da sua cobertura.



[www.inovefix.com.br](http://www.inovefix.com.br)

Acabamento:  
**Zincado**



Avenida Esco, 263 - Embu das Artes  
SP CEP 06833-085



## Linha madeira



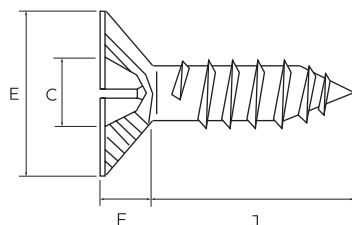

### Parafuso madeira Chip cabeça chata phillips

Material: Aço baixo carbono  
Acabamento: Zincado ou Bicromatizado

#### Dimensões

Diâmetro	3,0	3,5	4,0	4,5	5,0	6,0
E (máx)	6,20	6,80	7,50	8,10	9,50	10,80
F (máx)	1,90	2,10	2,30	2,70	2,90	3,20
C (ref)	2	2	2	2	2	2 ou 3
passo	1,35	1,60	1,80	2,00	2,20	2,60

J	3,0	3,5	4,0	4,5	5,0	6,0
10	R\$ 8,68	R\$ 11,07				
12	R\$ 10,04	R\$ 11,75	R\$ 13,73			
14	R\$ 10,21	R\$ 12,77	R\$ 14,88	R\$ 19,09		
16	R\$ 11,40	R\$ 14,64		R\$ 23,33		
20	R\$ 13,62	R\$ 17,02	R\$ 22,98	R\$ 26,91		
22	R\$ 14,39	R\$ 17,57	R\$ 23,05	R\$ 28,20	R\$ 34,00	
25	R\$ 15,02	R\$ 19,18	R\$ 25,57	R\$ 28,97	R\$ 38,12	R\$ 59,16
30	R\$ 15,98	R\$ 22,85	R\$ 30,37	R\$ 33,54	R\$ 44,98	R\$ 67,09
35		R\$ 26,85	R\$ 33,08	R\$ 38,12	R\$ 52,60	R\$ 76,69
40	R\$ 26,66	R\$ 28,20	R\$ 36,89	R\$ 42,10	R\$ 54,88	R\$ 82,18
45		R\$ 33,00	R\$ 39,86	R\$ 46,75	R\$ 59,68	R\$ 90,02
50			R\$ 44,22	R\$ 50,09	R\$ 65,34	R\$ 100,19
60			R\$ 53,36	R\$ 59,24	R\$ 78,41	
65				R\$ 64,36	R\$ 84,91	R\$ 129,90
70					R\$ 92,91	R\$ 139,36
80					R\$ 102,67	R\$ 153,56
90					R\$ 114,65	R\$ 173,39
100						R\$ 189,52

Preço de lista por cento

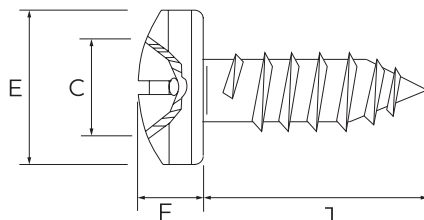
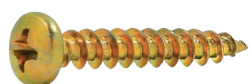

### Parafuso madeira Chip cabeça panela phillips

Material: Aço baixo carbono  
Acabamento: Zincado ou Bicromatizado

#### Dimensões

Diâmetro	3,0	3,5	4,0	4,5	5,0	6,0
E (máx)	5,50	6,90	7,50	8,20	9,50	10,80
F (máx)	2,34	2,60	2,80	3,05	3,55	3,95
C (ref)	2	2	2	2	2	3
passo	1,35	1,60	1,80	2,00	2,20	2,60

J	3,0	3,5	4,0	4,5	5,0	6,0
10	R\$ 10,63	R\$ 14,94				
12	R\$ 11,13	R\$ 16,04	R\$ 21,35			
14	R\$ 12,39	R\$ 17,87	R\$ 23,01	R\$ 28,51		
16	R\$ 13,12	R\$ 19,52	R\$ 24,78	R\$ 30,61		
20	R\$ 15,49	R\$ 22,05	R\$ 29,46	R\$ 34,84		
22	R\$ 14,44	R\$ 21,93	R\$ 29,69	R\$ 35,19		
25	R\$ 17,94	R\$ 23,97	R\$ 34,34	R\$ 37,16	R\$ 50,67	R\$ 77,34
30	R\$ 18,65	R\$ 27,92	R\$ 40,70	R\$ 42,81	R\$ 56,63	R\$ 87,87
35		R\$ 30,63	R\$ 40,61	R\$ 47,81	R\$ 63,15	R\$ 96,64
40		R\$ 33,77	R\$ 43,67	R\$ 50,73	R\$ 68,73	R\$ 104,40
45			R\$ 48,42	R\$ 55,87	R\$ 73,41	R\$ 113,67
50			R\$ 52,23	R\$ 59,30	R\$ 79,35	R\$ 122,31
60			R\$ 60,02	R\$ 69,80	R\$ 93,67	R\$ 141,23
70					R\$ 102,52	R\$ 159,48
80					R\$ 113,19	R\$ 179,77

Preço de lista por cento

## Parafuso madeira

### Chip cabeça flangeada phillips

Material: Aço baixo carbono  
Acabamento: Zincado ou Bicromatizado

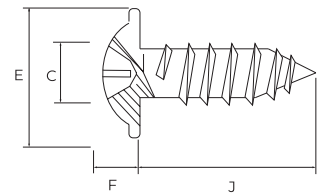

## Dimensões

Diâmetro	3,0	3,5	4,0	4,5	5,0	6,0
E (máx)	7,80	8,50	9,50	10,80	12,00	13,00
F (máx)	1,50	1,80	1,98	2,30	2,70	2,80
C (ref)	2	2	2	2	2	3
passo	1,35	1,60	1,80	2,00	2,20	2,60

J	3,0	3,5	4,0	4,5	5,0	6,0
10	R\$ 10,66	R\$ 15,99				
12	R\$ 10,84	R\$ 16,17	R\$ 18,16			
14	R\$ 12,26	R\$ 16,34	R\$ 23,09			
16	R\$ 13,85	R\$ 18,30	R\$ 25,03	R\$ 32,00		
20	R\$ 15,64	R\$ 21,66	R\$ 28,07	R\$ 36,08	R\$ 47,14	
22	R\$ 15,50	R\$ 20,51	R\$ 28,34	R\$ 35,48		
25	R\$ 16,67	R\$ 22,51	R\$ 30,51	R\$ 37,23	R\$ 49,79	R\$ 71,27
30	R\$ 19,01	R\$ 27,51	R\$ 35,01	R\$ 42,63	R\$ 57,59	R\$ 81,61
35		R\$ 29,51	R\$ 40,01	R\$ 47,89	R\$ 63,63	R\$ 89,41
40		R\$ 31,97	R\$ 42,95	R\$ 51,51	R\$ 66,52	R\$ 96,01
45		R\$ 30,89	R\$ 45,98	R\$ 56,06	R\$ 72,09	R\$ 106,81
50			R\$ 49,32	R\$ 60,60	R\$ 73,32	R\$ 116,54
55					R\$ 90,77	
60				R\$ 70,14	R\$ 92,15	R\$ 134,29
70					R\$ 100,44	

Preço de lista por cento

## Parafuso madeira

### Chip oval phillips

Material: Aço baixo carbono  
Acabamento: Zincado ou Bicromatizado

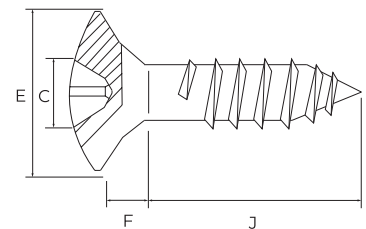

## Dimensões

Diâmetro	4,0
E (máx)	??
F (máx)	??
C (ref)	??

J	4,0
14	R\$ 14,71
16	R\$ 15,44

Preço de lista por cento

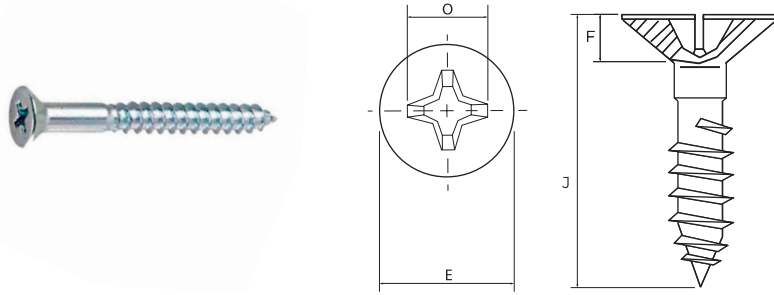

### Parafuso madeira Cabeça chata phillips

Material: Aço baixo carbono  
Acabamento: Zincado ou Bicromatizado

#### Dimensões

Diâmetro	2,5	2,8	3,2	3,5	3,8	4,2	4,5	4,8	5,5	6,1
E (máx)	5,00	5,60	6,40	7,10	7,70	8,10	9,10	9,70	11,10	12,70
F (máx)	1,50	1,70	1,90	2,10	2,30	2,50	2,70	2,90	3,30	3,70
O (ref)	1	1	2	2	2	2	2	2	3	3
passo	0,91	1,06	1,27	1,41	1,59	1,69	1,81	1,95	2,31	2,54

	2,5	2,8	3,2	3,5	3,8	4,2	4,5	4,8	5,5	6,1
10	R\$ 9,64	R\$ 9,95								
12	R\$ 10,35	R\$ 10,49	R\$ 12,06	R\$ 14,66	R\$ 16,33					
16	R\$ 11,78	R\$ 11,89	R\$ 14,55	R\$ 21,09	R\$ 17,91	R\$ 20,51	R\$ 24,37	R\$ 29,69		
20	R\$ 12,26	R\$ 12,97	R\$ 16,06	R\$ 18,44	R\$ 20,33	R\$ 23,57	R\$ 29,01	R\$ 30,43	R\$ 38,98	
22	R\$ 13,33	R\$ 14,16	R\$ 17,25	R\$ 19,96	R\$ 22,55	R\$ 24,83	R\$ 30,38	R\$ 32,96	R\$ 41,14	R\$ 54,65
25	R\$ 13,80	R\$ 15,24	R\$ 19,19	R\$ 28,46	R\$ 23,39	R\$ 26,73	R\$ 22,15	R\$ 38,10	R\$ 45,15	R\$ 58,05
30		R\$ 18,44	R\$ 22,17	R\$ 35,00	R\$ 28,64	R\$ 34,30	R\$ 41,11	R\$ 43,90	R\$ 54,00	R\$ 69,16
40		R\$ 21,68	R\$ 28,33	R\$ 44,95	R\$ 36,02	R\$ 41,79	R\$ 34,46	R\$ 56,56	R\$ 67,07	R\$ 87,68
45				R\$ 51,90	R\$ 40,03	R\$ 45,69	R\$ 53,77	R\$ 62,05	R\$ 75,81	R\$ 95,30
50						R\$ 43,41	R\$ 50,02	R\$ 41,85	R\$ 72,91	R\$ 87,63
55						R\$ 45,94	R\$ 62,67	R\$ 71,38	R\$ 80,40	R\$ 94,01
65							R\$ 70,80	R\$ 81,20	R\$ 91,27	R\$ 111,91
75							R\$ 78,29	R\$ 89,32	R\$ 100,66	R\$ 123,44
90									R\$ 119,75	R\$ 148,24
100									R\$ 130,30	R\$ 161,62

Preço de lista por cento

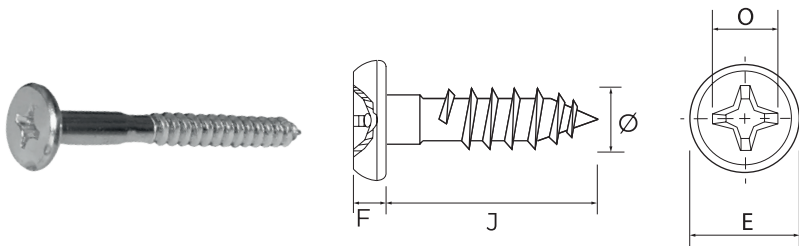

### Parafuso madeira Tampinha phillips

Material: Aço baixo carbono  
Acabamento: Zincado ou Bicromatizado

#### Dimensões

Diâmetro	4,2	4,8	5,5
E (máx.)	13,20	13,20	13,20
F (máx.)	2,40	2,40	2,40
O (ref.)	2	2	3
passo	1,69	1,95	2,31

25		R\$ 52,66
30	R\$ 52,34	R\$ 62,15
40	R\$ 67,10	R\$ 79,56
45	R\$ 71,22	R\$ 85,68
50		R\$ 88,95
55		R\$ 94,33
60		R\$ 101,61
65		R\$ 105,40
75		R\$ 119,33
90		R\$ 153,18
100		R\$ 171,70

Preço de lista por cento

## Parafuso estrutural Tampinha Phillips

Material: Aço baixo carbono  
Acabamento: Zincado ou Bicromatizado

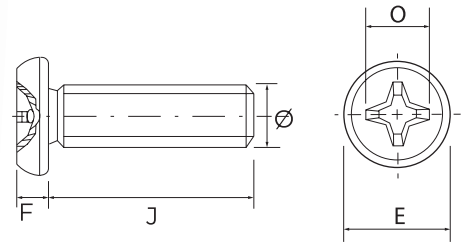
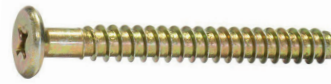

### Dimensões

Diâmetro	7,0	7,0	7,0
E (ref.)	13	14	17

J	40	R\$ 99,20	R\$ 116,96	R\$ 131,22
	50	R\$ 120,79	R\$ 138,66	R\$ 160,61
	60	R\$ 148,17	R\$ 168,06	R\$ 182,31
	70	R\$ 171,14	R\$ 189,65	R\$ 203,90
	75	R\$ 179,65	R\$ 200,50	R\$ 214,75
	80	R\$ 188,16	R\$ 211,24	R\$ 225,49
	90	R\$ 205,92	R\$ 232,94	R\$ 247,09
	100	R\$ 224,96	R\$ 254,53	R\$ 268,79
	110	R\$ 246,24	R\$ 276,13	R\$ 290,38
	120	R\$ 265,81	R\$ 297,72	R\$ 311,97
	130	R\$ 282,83	R\$ 319,42	R\$ 333,56
	140	R\$ 302,82	R\$ 341,01	R\$ 355,26
	150	R\$ 327,50	R\$ 362,60	R\$ 376,85

Preço de lista por cento

## Parafuso estrutural Tampinha Allen

Material: Aço baixo carbono  
Acabamento: Zincado ou Bicromatizado

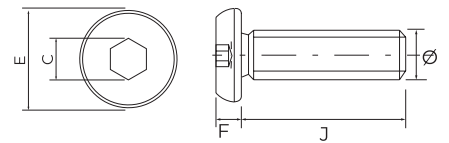

### Dimensões

Diâmetro	7	7	7
E (ref.)	13	14	17

J	40	R\$ 86,18	R\$ 105,80	R\$ 120,23
	50	R\$ 118,29	R\$ 123,25	R\$ 145,48
	60	R\$ 142,35	R\$ 148,49	R\$ 162,92
	70	R\$ 163,96	R\$ 165,93	R\$ 180,35
	75	R\$ 165,60	R\$ 174,65	R\$ 189,08
	80	R\$ 181,45	R\$ 183,38	R\$ 197,79
	90	R\$ 201,00	R\$ 200,82	R\$ 215,23
	100	R\$ 220,55	R\$ 218,26	R\$ 232,68
	110	R\$ 235,99	R\$ 235,70	R\$ 250,12
	120	R\$ 258,22	R\$ 253,14	R\$ 267,56
	130	R\$ 279,72	R\$ 270,59	R\$ 285,00
	140	R\$ 298,35	R\$ 288,03	R\$ 302,45
	150	R\$ 318,62	R\$ 305,47	R\$ 319,89

Preço de lista por cento

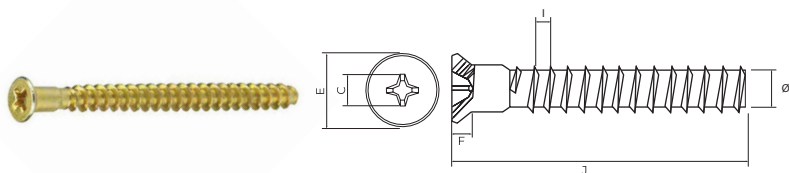

**Parafuso estrutural**  
Escareado phillips

Material: Aço baixo carbono  
Acabamento: Zincado ou Bicromatizado

**Dimensões**

Diâmetro	5,0	7,0
----------	-----	-----

<b>J</b>	40	R\$ 49,17	R\$ 87,21
	50	R\$ 52,34	R\$ 105,22
	60	R\$ 68,58	R\$ 133,09
	70		R\$ 152,02
	80		R\$ 171,47

Preço de lista por cento

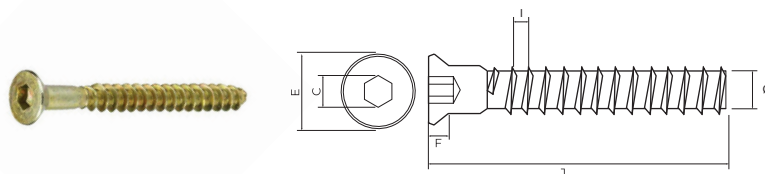

**Parafuso estrutural**  
Escareado Allen

Material: Aço baixo carbono  
Acabamento: Zincado ou Bicromatizado

**Dimensões**

Diâmetro	5,0	7,0
----------	-----	-----

<b>J</b>	40	R\$ 48,12	R\$ 87,21
	50	R\$ 65,41	R\$ 106,56
	60	R\$ 75,96	R\$ 132,57
	70		R\$ 150,17
	80		R\$ 170,44

Preço de lista por cento

## Pino Girofix de aço

Material: Aço baixo carbono  
Acabamento: Zincado ou Bicromatizado

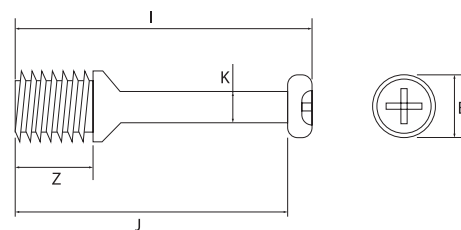

### Dimensões

E (ref.) (mm)	6,0
K (ref.) (mm)	3,0
Z (mm)	8,5
I (mm)	31,4
J (mm)	20,6
Preço lista (cento)	R\$ 46,19

Preço de lista por cento

## Castanhas Zamac

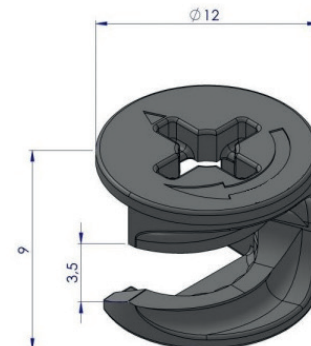
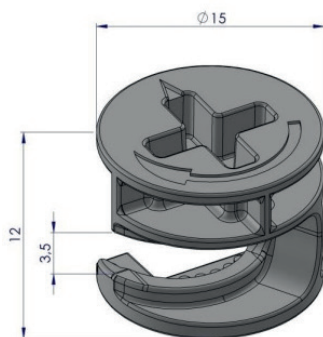

### Dimensões

MODELO	"Castanha 15 x 12"	MODELO	"Castanha 12x9"
Preço lista (cento)	R\$ 100,23	Preço lista (cento)	R\$ 62,33

Preço de lista por cento



## PARAFUSO PRISIONEIRO DE ROSCA DUPLA

# Fixação segura para os pés do seu sofá



O parafuso prisioneiro de rosca dupla da **INOVE-FIX** é a escolha perfeita para garantir a fixação segura dos pés do seu sofá. Com sua rosca dupla, oferece estabilidade e resistência superiores, evitando solturas indesejadas. Fabricado com materiais de alta qualidade e acabamento zincado, o parafuso prisioneiro da **INOVE-FIX** proporciona durabilidade e um aspecto estético agradável. Simplifique sua vida e desfrute de um sofá estável e seguro com o parafuso prisioneiro de rosca dupla da **INOVE-FIX**.



O parafuso prisioneiro de rosca dupla da Inove-Fix oferece fixação segura e estável para os pés do sofá. Com sua máquina de rosca e rosca soberba, garante instalação fácil e firmeza.



## **Linha auto atarraxante**



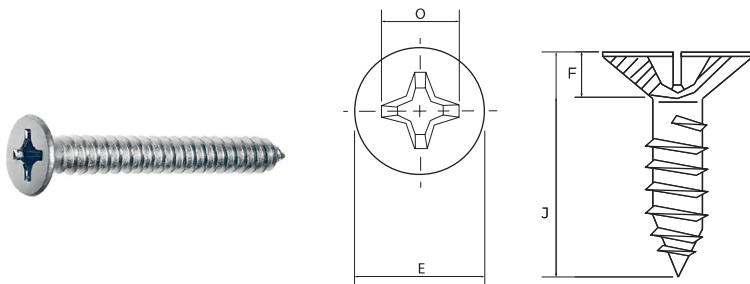

**Parafuso auto atarraxante**  
**Cabeça chata phillips**  
 Material: Aço baixo carbono  
 Acabamento: Zincado ou Bicromatizado

**Dimensões**

Diâmetro	2,2	2,9	3,5	3,9	4,2	4,8	5,5	6,3
ØE máx	4,3	5,5	6,8	7,5	8,1	9,5	10,8	12,5
A máx	1,3	1,7	2,1	2,3	2,5	3,0	3,4	3,8
O máx	2,6	3,0	4,2	4,4	4,6	5,0	6,5	7,1
Chave	1	1	2	2	2	2	3	3

<b>J</b>	6,5	R\$ 6,57	R\$ 7,94	R\$ 12,54					
	9,5	R\$ 6,82	R\$ 9,02	R\$ 14,69	R\$ 18,79	R\$ 20,69	R\$ 31,94		
	13	R\$ 7,42	R\$ 11,74	R\$ 17,25	R\$ 20,96	R\$ 24,98	R\$ 35,10	R\$ 46,98	R\$ 63,52
	16		R\$ 12,84	R\$ 20,18	R\$ 24,98	R\$ 27,64	R\$ 39,82	R\$ 49,44	R\$ 72,07
	19		R\$ 15,60	R\$ 23,11	R\$ 27,60	R\$ 33,66	R\$ 44,18	R\$ 57,32	R\$ 81,11
	22			R\$ 24,69	R\$ 29,35	R\$ 36,21	R\$ 47,30	R\$ 58,18	R\$ 77,09
	25			R\$ 27,33	R\$ 32,71	R\$ 38,42	R\$ 51,50	R\$ 65,49	R\$ 94,42
	32				R\$ 40,10	R\$ 46,98	R\$ 63,75	R\$ 78,68	R\$ 112,38
	38					R\$ 50,83	R\$ 69,59	R\$ 85,06	R\$ 118,92
	45						R\$ 81,98	R\$ 98,30	R\$ 136,53
	50					R\$ 72,76	R\$ 87,85	R\$ 110,19	R\$ 147,08

Preço de lista por cento

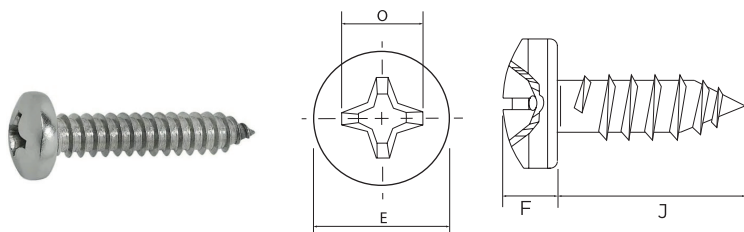

**Parafuso auto atarraxante**  
**Cabeça panela phillips**  
 Material: Aço baixo carbono  
 Acabamento: Zincado ou Bicromatizado

**Dimensões**

Diâmetro	2,2	2,9	3,5	3,9	4,2	4,8	5,5	6,3
ØE máx	4,2	5,6	6,9	7,5	8,2	9,5	10,8	12,3
F máx	1,8	2,2	2,6	2,8	3,05	3,55	3,95	4,55
O máx	2,6	3,0	4,2	4,4	4,6	5,0	6,5	7,1
Chave	1	1	2	2	2	2	3	3

<b>J</b>	6,5	R\$ 7,38	R\$ 9,58	R\$ 15,91					
	9,5	R\$ 8,10	R\$ 11,31	R\$ 18,20	R\$ 22,09	R\$ 26,69	R\$ 37,24		
	13	R\$ 9,07	R\$ 13,45	R\$ 20,54	R\$ 24,64	R\$ 29,41	R\$ 42,71	R\$ 51,86	R\$ 82,28
	16		R\$ 15,19	R\$ 22,26	R\$ 26,78	R\$ 32,53	R\$ 46,82	R\$ 60,69	R\$ 88,42
	19		R\$ 15,87	R\$ 25,37	R\$ 30,88	R\$ 36,13	R\$ 50,76	R\$ 64,94	R\$ 96,15
	22			R\$ 26,86	R\$ 31,23	R\$ 38,18	R\$ 52,54	R\$ 72,51	R\$ 98,37
	25			R\$ 29,86	R\$ 34,86	R\$ 41,18	R\$ 58,38	R\$ 74,00	R\$ 105,54
	32				R\$ 42,76	R\$ 48,91	R\$ 67,84	R\$ 85,21	R\$ 122,88
	38					R\$ 49,75	R\$ 72,76	R\$ 90,61	R\$ 138,73
	45						R\$ 84,57	R\$ 103,63	R\$ 146,97
	50						R\$ 89,65	R\$ 113,69	R\$ 160,13

Preço de lista por cento

## Parafuso auto atarraxante Flangeada fenda combinada

Material: Aço baixo carbono  
Acabamento: Zincado ou Bicromatizado

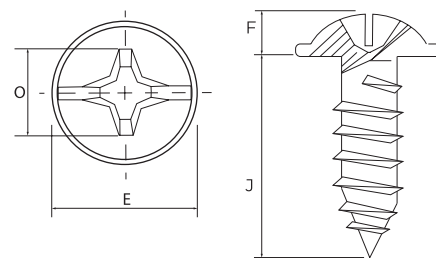

### Dimensões

Diâmetro	3,9	4,2	4,8
ØE máx	9,5	10,8	12,0
F máx	2,0	2,3	2,7

J	9,5		R\$ 25,73	
	32	R\$ 29,12	R\$ 33,40	R\$ 43,97
	38		R\$ 38,10	R\$ 49,04

Preço de lista por cento

## Parafuso auto atarraxante Cabeça panela phillips ponta piloto

Material: Aço baixo carbono  
Acabamento: Zincado ou Bicromatizado

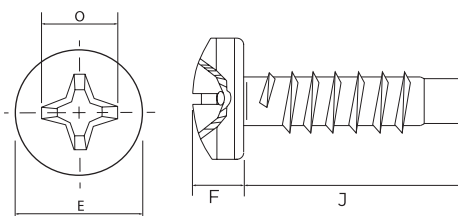

### Dimensões

Diâmetro	3,9	4,2	4,8
E (máx)	7,50	8,20	9,50
F (máx)	2,25	2,45	2,80
O (máx)	1,30	1,40	1,60
passo	1,34	1,41	1,59

J	25	R\$ 36,26	R\$ 42,69	R\$ 54,15
	32	R\$ 43,15	R\$ 50,08	R\$ 64,40
	38		R\$ 54,45	R\$ 74,20
	50			R\$ 89,18

Preço de lista por cento

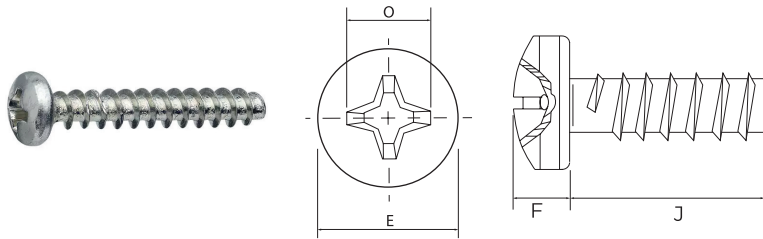

**Parafuso plastic**  
Cabeça panela phillips

Material: Aço baixo carbono  
Acabamento: Zincado ou Bicromatizado

**Dimensões**

Diâmetro	3,0	3,5	4,0	4,5	5,0
E (máx)	5,50	6,90	7,50	8,20	9,50
F (máx)	2,34	2,60	2,80	3,05	3,55
O (ref)	2	2	2	2	2
passo	1,35	1,60	1,80	2,00	2,20

<b>J</b>	8	R\$ 10,83	R\$ 13,64	R\$ 14,62		
	10	R\$ 11,37	R\$ 14,40	R\$ 16,45		
	12	R\$ 11,70	R\$ 14,83	R\$ 18,83	R\$ 21,46	R\$ 28,42
	14	R\$ 13,10	R\$ 15,80	R\$ 19,48	R\$ 22,09	R\$ 31,59
	16	R\$ 13,21	R\$ 16,67	R\$ 19,91	R\$ 25,26	R\$ 30,95
	20	R\$ 14,51	R\$ 18,62	R\$ 22,07	R\$ 29,23	R\$ 33,98
	22	R\$ 15,59	R\$ 18,83	R\$ 23,05	R\$ 30,29	R\$ 35,67
	25	R\$ 16,02	R\$ 21,05	R\$ 26,02	R\$ 32,71	R\$ 38,73
	30	R\$ 18,24	R\$ 23,97	R\$ 27,75	R\$ 34,93	R\$ 40,94
	35		R\$ 26,02	R\$ 32,29	R\$ 39,47	R\$ 47,27
	40		R\$ 26,67	R\$ 33,59	R\$ 44,74	R\$ 50,44
	45				R\$ 47,59	R\$ 52,55
	50				R\$ 62,67	R\$ 68,47

Preço de lista por cento

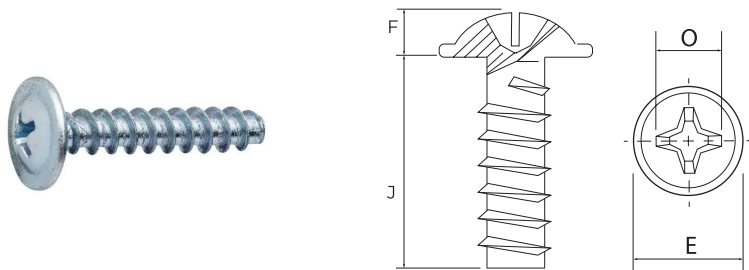

**Parafuso plastic**  
Cabeça flangeada phillips

Material: Aço baixo carbono  
Acabamento: Zincado ou Bicromatizado

**Dimensões**

Diâmetro	3,0	3,5	4,0	4,5	5,0
E (máx)	7,80	8,50	9,50	10,80	12,00
F (máx)	1,48	1,80	1,98	2,29	2,70
O (ref)	2	2	2	2	2
passo	1,35	1,60	1,80	2,00	2,20

<b>J</b>	8	R\$ 11,37	R\$ 14,29	R\$ 16,67		R\$ 24,31
	10	R\$ 11,48	R\$ 14,72	R\$ 17,75		R\$ 27,58
	12	R\$ 12,13	R\$ 15,59	R\$ 17,10	R\$ 36,62	R\$ 28,32
	14	R\$ 12,99	R\$ 16,24	R\$ 20,02	R\$ 38,86	R\$ 29,79
	16	R\$ 14,08	R\$ 17,75	R\$ 20,56	R\$ 44,22	R\$ 31,59
	20	R\$ 18,72	R\$ 18,18		R\$ 26,31	R\$ 60,42
	22	R\$ 15,05	R\$ 19,05	R\$ 25,59	R\$ 28,18	R\$ 37,04
	25	R\$ 16,02	R\$ 27,41	R\$ 23,21	R\$ 31,13	R\$ 66,41
	30	R\$ 18,67	R\$ 30,48	R\$ 29,05	R\$ 36,19	R\$ 68,83
	35		R\$ 34,17	R\$ 32,29	R\$ 37,14	R\$ 46,01
	40		R\$ 29,70	R\$ 35,10	R\$ 42,63	R\$ 56,56
	45				R\$ 45,37	R\$ 65,94
	50				R\$ 55,81	R\$ 73,01

Preço de lista por cento

## Parafuso auto atarraxante

Cabeça panela fenda simples

Material: Aço baixo carbono  
Acabamento: Zincado ou Bicromatizado

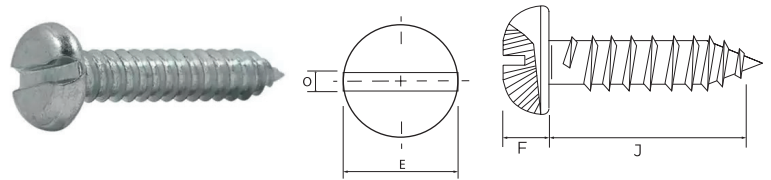

### Dimensões

Diâmetro	2,2	2,9	3,5	3,9	4,2	4,8	5,5	6,3
E (máx)	4,20	5,60	6,90	7,50	8,20	9,50	10,80	12,50
F (máx)	1,35	1,75	2,10	2,25	2,45	2,80	3,20	3,65
O (ref) passo	0,90	1,00	1,30	1,30	1,40	1,60	1,80	1,90
	0,79	1,06	1,27	1,34	1,41	1,59	1,81	1,81

J	6,5	R\$ 10,71	R\$ 14,80	R\$ 21,28	R\$ 27,67				
	9,5	R\$ 11,56	R\$ 17,97	R\$ 24,67	R\$ 28,70	R\$ 34,20	R\$ 48,43		
	13	R\$ 14,10	R\$ 21,15	R\$ 29,33	R\$ 31,18	R\$ 37,50	R\$ 56,27	R\$ 67,03	R\$ 97,97
	16		R\$ 22,00	R\$ 31,45	R\$ 36,54	R\$ 43,34	R\$ 57,51	R\$ 73,45	R\$ 111,20
	19		R\$ 23,06	R\$ 36,33	R\$ 40,66	R\$ 48,57	R\$ 64,93	R\$ 81,36	R\$ 114,01
	22		R\$ 31,45	R\$ 39,50	R\$ 46,44	R\$ 52,90	R\$ 67,82	R\$ 86,37	R\$ 126,04
	25			R\$ 43,02	R\$ 48,50	R\$ 57,23	R\$ 73,74	R\$ 97,60	R\$ 140,07
	32				R\$ 58,54	R\$ 67,54	R\$ 90,23	R\$ 113,84	R\$ 156,11
	38					R\$ 75,17	R\$ 102,40	R\$ 125,67	R\$ 180,17
	45					R\$ 115,67	R\$ 118,88	R\$ 151,98	R\$ 220,89
50						R\$ 139,16	R\$ 174,13	R\$ 247,14	

Preço de lista por cento

## Parafuso para telha

Com e sem conjunto de vedação

Material: Aço baixo carbono  
Acabamento: Zincado ou Bicromatizado

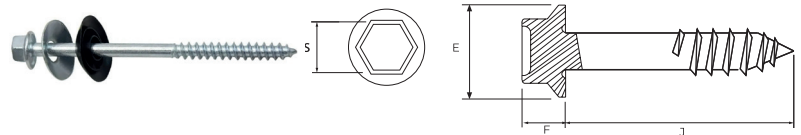

### Dimensões

Diâmetro	5/16"	5/16"
Chave S	11 mm	10 mm

J		Contém conjunto de vedação?		Contém conjunto de vedação?	
		NÃO	SIM	NÃO	SIM
	65	R\$ 184,45	R\$ 253,15	R\$ 176,61	R\$ 245,31
	85	R\$ 219,78	R\$ 288,47	R\$ 211,94	R\$ 280,63
	110	R\$ 260,43	R\$ 329,13	R\$ 252,59	R\$ 321,29
	130	R\$ 299,34	R\$ 368,04	R\$ 291,50	R\$ 360,20
	150	R\$ 336,41	R\$ 405,11	R\$ 328,57	R\$ 397,27
	165	R\$ 362,93	R\$ 431,63	R\$ 355,09	R\$ 423,79
	180	R\$ 389,48	R\$ 458,17	R\$ 381,61	R\$ 450,31
	200	R\$ 402,23	R\$ 470,92	R\$ 401,84	R\$ 470,54

Preço de lista por cento

### KIT DE VEDAÇÃO PARA PARAFUSO TELHA

Peças/kit	100 uni	50 uni
Arruela de metal	R\$ 52,37	R\$ 26,18
Arruela de PVC	R\$ 27,88	R\$ 13,94
Conjunto Arruela de metal + PVC	R\$ 80,24	R\$ 40,12

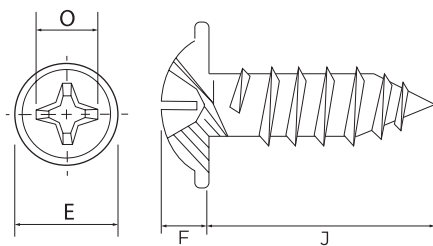

**Parafuso flangeado**  
Cabeça phillips ponta de agulha

Material: Aço baixo carbono  
Acabamento: Zincado ou Bicromatizado

**Dimensões**

Diâmetro	4,2
E (máx)	10,60
F (máx)	2,70
C (ref)	4,70

<b>J</b>	13	R\$ 19,66
	16	R\$ 22,69
	19	R\$ 23,32
	25	R\$ 27,91

Preço de lista por cento

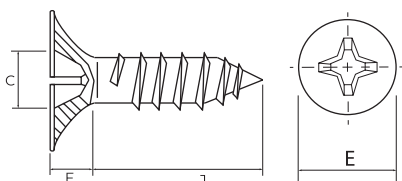

**Parafuso trombeta**  
Cabeça phillips ponta de agulha

Material: Aço baixo carbono  
Acabamento: Fosfatizado

**Dimensões**

Diâmetro	3,5
E (máx)	8,15
F (máx)	4,65
C (ref)	4,70

<b>J</b>	25	R\$ 37,51
	35	R\$ 47,54
	45	R\$ 58,67
	55	R\$ 68,32

Preço de lista por cento

**Parafuso auto-fix**  
sextavado flangeado fenda simples

Material: Aço baixo carbono  
Acabamento: Zincado

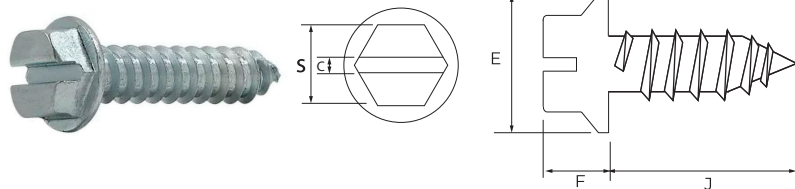

**Dimensões**

Diâmetro	3,5	3,9	4,2	4,8	5,5	6,3
ØE máx	8,33	8,33	8,84	10,51	10,97	13,21
G máx	1,35	1,57	1,88	2,03	2,62	2,82
C máx	1,22	1,22	1,37	1,52	1,70	1,90
F máx	2,36	2,36	2,79	3,05	3,94	4,83
S máx	6,35	6,35	6,35	7,92	7,92	9,52

<b>J</b>	9,5	R\$ 17,23	R\$ 18,10	R\$ 23,84	R\$ 30,52		
	13	R\$ 19,07	R\$ 20,39	R\$ 26,45	R\$ 33,86	R\$ 41,81	R\$ 59,85
	16	R\$ 20,70	R\$ 22,38	R\$ 28,75	R\$ 37,00	R\$ 45,52	R\$ 66,06
	19	R\$ 22,33	R\$ 24,36	R\$ 31,64	R\$ 42,82	R\$ 49,43	R\$ 70,37
	22	R\$ 24,66	R\$ 27,05	R\$ 33,94	R\$ 43,76	R\$ 53,24	R\$ 75,58
	25	R\$ 26,29	R\$ 29,03	R\$ 36,13	R\$ 46,78	R\$ 57,14	R\$ 80,90
	32			R\$ 40,83	R\$ 53,99	R\$ 66,06	R\$ 93,12
	38				R\$ 69,00	R\$ 82,79	R\$ 113,15
	45				R\$ 76,20	R\$ 91,71	R\$ 125,38
	50				R\$ 83,40	R\$ 100,62	R\$ 137,60

Preço de lista por cento



MATERIAL:  
AÇO MÉDIO CARBONO  
CEMENTADO E TEMPERADO  
ACABAMENTO: FOSFATIZADO



## Fixação Perfeita para Drywall

O parafuso trombeta ponta de agulha, também conhecido como parafuso Drywall ou parafuso para gesso, é projetado especificamente para a fixação de placas de gesso em estruturas metálicas ou madeira. Ele possui um design único que facilita sua penetração no material, minimizando o risco de danificar a superfície.



Fixação de gesso sem preocupações?  
**Inove Fix é a melhor escolha!**



**Linha  
construção  
civil**



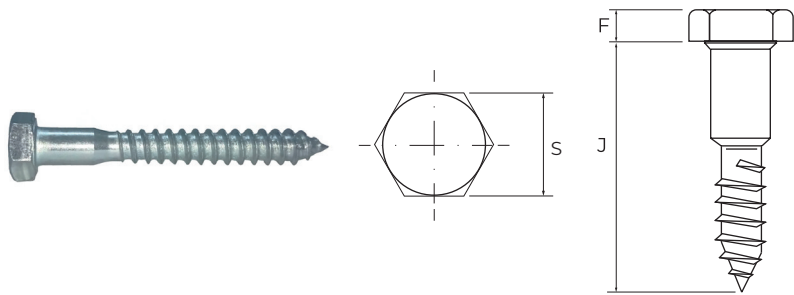

## Parafuso sextavado Rosca Soberba

Material: Aço baixo carbono  
Acabamento: Zincado

### Dimensões

S (máx)	3/16"	1/4"	5/16"	3/8"	1/2"
---------	-------	------	-------	------	------

S	25	30	35	40	45	50	55	60	65	70	75	80	90	100	110	120
	R\$ 47,82	R\$ 53,04	R\$ 58,25	R\$ 63,46	R\$ 68,67	R\$ 81,69	R\$ 86,90	R\$ 92,11	R\$ 97,32	R\$ 102,54	R\$ 107,75					
												R\$ 105,43	R\$ 114,79	R\$ 131,96	R\$ 141,32	R\$ 150,68
												R\$ 160,04	R\$ 169,40	R\$ 178,76	R\$ 188,12	R\$ 197,48
												R\$ 240,07	R\$ 255,49	R\$ 270,91	R\$ 283,68	R\$ 301,76
												R\$ 317,18	R\$ 324,64	R\$ 329,22	R\$ 338,55	R\$ 343,67
												R\$ 388,55	R\$ 396,11	R\$ 409,00	R\$ 411,00	R\$ 423,44
												R\$ 455,88	R\$ 466,11	R\$ 479,44	R\$ 483,44	R\$ 493,44
												SOB CONSULTA	SOB CONSULTA	SOB CONSULTA	SOB CONSULTA	SOB CONSULTA
												SOB CONSULTA	SOB CONSULTA	SOB CONSULTA	SOB CONSULTA	SOB CONSULTA
												SOB CONSULTA	SOB CONSULTA	SOB CONSULTA	SOB CONSULTA	SOB CONSULTA
												SOB CONSULTA	SOB CONSULTA	SOB CONSULTA	SOB CONSULTA	SOB CONSULTA
												SOB CONSULTA	SOB CONSULTA	SOB CONSULTA	SOB CONSULTA	SOB CONSULTA

Preço de lista por cento

## Linha de parafusos Brocantes

### PBSAV / PARAFUSO AUTOPERFORANTE PONTA BROCA CABEÇA SEXTAVADA C/ ARRUELA VULCANIZADA



ZINCADO CLARO  
- BW Arruela  
Móvel

MEDIDA	EQUIV.	CHAVE	PONTA	UN	"PREÇO LISTA"
#10-16X3	8X19 MM	5/16"	3	CT	R\$ 87,24
#12-14X3/4	5,5X19 MM	5/16"	3	CT	R\$ 99,77
#12-14X1	5,5X25 MM	5/16"	3	CT	R\$ 109,91
#12-14X1.1/2	5,5X38 MM	5/16"	3	CT	R\$ 145,95
#12-14X2	5,5X50 MM	5/16"	3	CT	R\$ 157,43
#12-14X2.1/2	5,5X63 MM	5/16"	3	CT	R\$ 198,34
#12-14X3	5,5X76 MM	5/16"	4	CT	R\$ 233,63
#12-14X3.1/2	5,5X89 MM	5/16"	4	CT	R\$ 260,25
#12-14X4	5,5X102 MM	5/16"	4	CT	R\$ 285,88
#12-14X5	5,5X125 MM	5/16"	4	CT	R\$ 356,86
#12/14-14X5	5,5X125 MM	8MM	4	CT	R\$ 285,92
#14-14X3/4	6,3X19 MM	3/8"	3	CT	R\$ 136,54
#14-14X1	6,3X25 MM	3/8"	3	CT	R\$ 168,57
#14-14X1.1/2	6,3X38 MM	3/8"	3	CT	R\$ 211,16
#14-14X2	6,3X50 MM	3/8"	3	CT	R\$ 261,73
#14-14X2.1/2	6,3X63 MM	3/8"	3	CT	R\$ 310,17
#14-14X3	6,3X76 MM	3/8"	3	CT	R\$ 341,08

**PBSAV / PARAFUSO AUTOPERFORANTE PONTA BROCA CABEÇA SEXTAVADA C/ ARRUELA VULCANIZADA**

INOX 410  
PASSIVADO -  
BW Arruela Móvel

MEDIDA	EQUIV.	CHAVE	PONTA	UN	"PREÇO LISTA"
#12-14X3/4	5,5X19 MM	5/16"	3	CT	R\$ 239,43
#12-14X1	5,5X25 MM	5/16"	3	CT	R\$ 263,80
#12-14X1.1/2	5,5X38 MM	5/16"	3	CT	R\$ 350,39
#12-14X2	5,5X50 MM	5/16"	3	CT	R\$ 377,84
#12-14X2.1/2	5,5X63 MM	5/16"	3	CT	R\$ 476,02
#12-14X3	5,5X76 MM	5/16"	4	CT	R\$ 560,72
#12-14X4	5,5X102 MM	5/16"	4	CT	R\$ 686,12
#14-14X3/4	6,3X19 MM	3/8"	3	CT	R\$ 327,68
#14-14X1	6,3X25 MM	3/8"	3	CT	R\$ 404,57

**PBSAV COSTURA / PARAF. AUTOP. PONTA BROCA # 1 C/SEXTAVADA C/ ARRUELA VULCANIZADA**

ZINCADO CLARO -  
BW Arruela Móvel  
- Especial para  
costura de telhas

MEDIDA	EQUIV.	CHAVE	PONTA	UN	"PREÇO LISTA"
#12-14X7/8	5,5X22 MM	5/16"	1	CT	R\$ 101,05
#14-14X7/8 Esp	6,3X22 MM	5/16"	1	CT	R\$ 137,52
#14-14X7/8	6,3X22 MM	3/8"	1	CT	R\$ 160,68

**PBS CUPPED / PARAFUSO AUTOPERFORANTE PONTA BROCA CABEÇA SEXTAVADA CUPPED C/ ARRUELA DE EPDM**

ZINCADO CLARO

MEDIDA	EQUIV.	CHAVE	PONTA	UN	"PREÇO LISTA"
#12-14X3/4	5,5X19 MM	5/16"	3	CT	R\$ 113,37
#12-14X1	5,5X25 MM	5/16"	3	CT	R\$ 122,24
#12-14X1.1/2	5,5X38 MM	5/16"	3	CT	R\$ 162,16
#12-14X2	5,5X50 MM	5/16"	3	CT	R\$ 174,98
#12-14X2.1/2	5,5X63 MM	5/16"	3	CT	R\$ 220,82
#12-14X3	5,5X76 MM	5/16"	4	CT	R\$ 260,74
#12-14X4	5,5X102 MM	5/16"	4	CT	R\$ 320,38

**PBS CUPPED / PARAFUSO AUTOPERFORANTE PONTA BROCA CABEÇA SEXTAVADA CUPPED C/ ARRUELA DE EPDM**

RUSPERT 1000H

MEDIDA	EQUIV.	CHAVE	PONTA	UN	"PREÇO LISTA"
#10-16X3/4	4,8X19 MM	5/16"	3	CT	R\$ 182,37
#12-14X3/4	5,5X19 MM	5/16"	3	CT	R\$ 231,66
#12-14X1	5,5X25 MM	5/16"	3	CT	R\$ 250,39
#12-14X1.1/4	5,5X32 MM	5/16"	3	CT	R\$ 293,77
#12-14X1.1/2	5,5X38 MM	5/16"	3	CT	R\$ 318,41
#12-14X2	5,5X50 MM	5/16"	3	CT	R\$ 364,75
#12-14X2.1/2	5,5X63 MM	5/16"	3	CT	R\$ 421,92
#12-14X3	5,5X76 MM	5/16"	3	CT	R\$ 463,32
#14-14X3/4	6,3X19 MM	3/8"	3	CT	R\$ 275,03
#14-14X1	6,3X25 MM	3/8"	3	CT	R\$ 324,33

**PBSF (LUH) / PARAFUSO AUTOPERFORANTE PONTA BROCA CABEÇA SEXTAVADA FLANGEADA LUH C/ ARRUELA DE EPDM**

RUSPERT 1000H -  
LUH M+

MEDIDA	EQUIV.	CHAVE	PONTA	UN	"PREÇO LISTA"
#12-14X3/4	5,5X19 MM	5/16"	3	CT	R\$ 170,05
#12-14X1	5,5X25 MM	5/16"	3	CT	R\$ 183,35
#12-14X1.1/2	5,5X38 MM	5/16"	3	CT	R\$ 243,24

PBS CUPPED / PARAFUSO AUTOPERFORANTE PONTA BROCA CABEÇA SEXTAVADA CUPPED C/ ARRUELA DE EPDM



RUSPERT 1000H COLORS

MEDIDA	EQUIV.	CHAVE	PONTA	UN	"PREÇO LISTA"
#12-14X3/4	5,5X19 MM	5/16"	3	CT	R\$ 290,31
#12-14X3/4	5,5X19 MM	5/16"	3	CT	R\$ 290,31
#12-14X3/4	5,5X19 MM	5/16"	3	CT	R\$ 290,31
#12-14X3/4	5,5X19 MM	5/16"	3	CT	R\$ 290,31
#12-14X3/4	5,5X19 MM	5/16"	3	CT	R\$ 290,31
#12-14X3/4	5,5X19 MM	5/16"	3	CT	R\$ 290,31
#12-14X3/4	5,5X19 MM	5/16"	3	CT	R\$ 290,31
#12-14X3/4	5,5X19 MM	5/16"	3	CT	R\$ 290,31
#12-14X3/4	5,5X19 MM	5/16"	3	CT	R\$ 290,31
#12-14X3/4	5,5X19 MM	5/16"	3	CT	R\$ 290,31

PBS CUPPED / PARAFUSO AUTOPERFORANTE PONTA BROCA CABEÇA SEXTAVADA CUPPED C/ ARRUELA DE EPDM



INOX 302 CAP + RUSPERT 1000H

MEDIDA	EQUIV.	CHAVE	PONTA	UN	"PREÇO LISTA"
# 12-14X1	5,5X25 MM	5/16"	3	CT	R\$ 478,11

PBS CUPPED COSTURA / PARAF. AUTOP. PONTA BROCA # 1 C/SEXTAVADA CUPPED COSTURA C/ ARRUELA DE EPDM



ZINCADO CLARO - Especial para costura de telhas

MEDIDA	EQUIV.	CHAVE	PONTA	UN	"PREÇO LISTA"
#12-14X7/8	5,5X22 MM	5/16"	1	CT	R\$ 123,23
#14-14X7/8	6,3X22 MM	5/16"	1	CT	R\$ 160,19
#14-14X7/8	6,3X22 MM	3/8"	1	CT	R\$ 165,61

PBSF (LUH) COSTURA / PARAFUSO AUTOPERFORANTE PONTA BROCA CABEÇA SEXTAVADA FLANGEADA LUH C/ ARRUELA DE EPDM



RUSPERT 1000H - LUH M+ - Especial para costura de telhas

MEDIDA	EQUIV.	CHAVE	PONTA	UN	"PREÇO LISTA"
#12-14X7/8 COST	5,5X22 MM	5/16"	1	CT	R\$ 184,84
#14-14X7/8 COST	6,3X22 MM	5/16"	1	CT	R\$ 224,26

PBS CUPPED COSTURA / PARAFUSO AUTOP. PONTA BROCA # 1 CABEÇA SEXTAVADA CUPPED COSTURA C/ ARRUELA DE EPDM



RUSPERT 1000 H - Especial para costura de telhas

MEDIDA	EQUIV.	CHAVE	PONTA	UN	"PREÇO LISTA"
#12-14X7/8	5,5X22 MM	5/16"	1	CT	R\$ 241,52
#14-14X7/8	6,3X22 MM	5/16"	1	CT	R\$ 256,31

PBS CUPPED COSTURA / PARAF. AUTOP. PONTA BROCA # 1 CABEÇA SEXTAVADA CUPPED COSTURA C/ ARRUELA DE EPDM



RUSPERT 1000 H COLORS - Especial para costura de telhas

MEDIDA	EQUIV.	CHAVE	PONTA	UN	"PREÇO LISTA"
#14-14X7/8	6,3X22 MM	5/16"	1	CT	R\$ 325,31
#14-14X7/8	6,3X22 MM	5/16"	1	CT	R\$ 325,31
#14-14X7/8	6,3X22 MM	5/16"	1	CT	R\$ 325,31
#14-14X7/8	6,3X22 MM	5/16"	1	CT	R\$ 325,31
#14-14X7/8	6,3X22 MM	5/16"	1	CT	R\$ 325,31
#14-14X7/8	6,3X22 MM	5/16"	1	CT	R\$ 325,31
#14-14X7/8	6,3X22 MM	5/16"	1	CT	R\$ 325,31
#14-14X7/8	6,3X22 MM	5/16"	1	CT	R\$ 325,31
#14-14X7/8	6,3X22 MM	5/16"	1	CT	R\$ 325,31
#14-14X7/8	6,3X22 MM	5/16"	1	CT	R\$ 325,31

**PBS CUPPED COSTURA / PARAF. AUTOP. PONTA BROCA # 1 C/SEXTAVADA CUPPED COSTURA C/ ARRUELA DE EPDM**

MEDIDA	EQUIV.	CHAVE	PONTA	UN	"PREÇO LISTA"
#14-14X7/8	6,3X22 MM	5/16"	1	CT	R\$ 522,47

INOX 302 CAP +  
RUSPERT 111H -  
Especial para  
costura de telhas

**PAS CUPPED COSTURA / PARAFUSO AUTOPERFORANTE PONTA AGULHA CABEÇA SEXTAVADA CUPPED C/ ARRUELA DE EPDM**

MEDIDA	EQUIV.	CHAVE	PONTA	UN	"PREÇO LISTA"
#10-25X3/4	4,8X19 MM	5/16"	AGULHA	CT	R\$ 229,46
#10-25X7/8	4,8X22 MM	5/16"	AGULHA	CT	R\$ 241,52

RUSPERT 1000H

**PBS CUPPED #5 / PARAFUSO AUTOPERFORANTE PONTA BROCA # 5 CABEÇA SEXTAVADA CUPPED C/ ARRUELA DE EPDM**

MEDIDA	EQUIV.	CHAVE	PONTA	UN	"PREÇO LISTA"
#12-24X1.1/2	5,5X38 MM	5/16"	5	CT	R\$ 330,24

RUSPERT 1000H -  
Especial para viga  
laminada

**PBS CUPPED INSULATION / PARAFUSO AUTOPERFORANTE PONTA BROCA ROSCA DUPLA CABEÇA SEXTAVADA CUPPED C/ ARRUELA DE EPDM**

ZINCADO CLARO

MEDIDA	EQUIV.	CHAVE	PONTA	UN	"PREÇO LISTA"
#12/14-14X2.3/8	5,5X60 MM	5/16"	4	CT	R\$ 240,53
#12/14-14X3.1/4	5,5X80 MM	5/16"	4	CT	R\$ 284,89
#12/14-14X4	5,5X102 MM	5/16"	4	CT	R\$ 341,08

**PBS CUPPED INSULATION / PARAFUSO AUTOPERFORANTE PONTA BROCA ROSCA DUPLA CABEÇA SEXTAVADA CUPPED C/ ARRUELA DE EPDM**

RUSPERT 1000H

MEDIDA	EQUIV.	CHAVE	PONTA	UN	"PREÇO LISTA"
#12/14-14X2	5,5X50 MM	5/16"	3	CT	R\$ 364,75
#12/14-14X2.3/8	5,5X60 MM	5/16"	4	CT	R\$ 422,90
#12/14-14X3.1/4	5,5X80 MM	5/16"	4	CT	R\$ 651,61
#12/14-14X3.1/2	5,5X89 MM	5/16"	4	CT	R\$ 743,29
#12/14-14X4	5,5X102 MM	5/16"	4	CT	R\$ 778,78
#12/14-14X5	5,5X125 MM	5/16"	4	CT	R\$ 991,71
#12/14-14X6	5,5X152 MM	5/16"	4	CT	R\$ 1.526,01

**PBS CUPPED INSULATION PARAFUSO AUTOPERFORANTE PONTA BROCA ROSCA DUPLA CABEÇA SEXTAVADA CUPPED C ARRUELA DE EPDM**

RUSPERT 1000H  
COLORS

MEDIDA	EQUIV.	CHAVE	PONTA	UN	"PREÇO LISTA"
#12/14-14X2.3/8	5,5X60 MM	5/16"	4	CT	R\$ 486,98
#12/14-14X3.1/4	5,5X80 MM	5/16"	4	CT	R\$ 750,19
#12/14-14X3.1/4	5,5X80 MM	5/16"	4	CT	R\$ 750,19
#12/14-14X3.1/4	5,5X80 MM	5/16"	4	CT	R\$ 750,19
#12/14-14X4	5,5X102 MM	5/16"	4	CT	R\$ 897,08
#12/14-14X5	5,5X127 MM	5/16"	4	CT	R\$ 1.143,52

PBS CUPPED INSULATION / PARAFUSO AUTOPERFORANTE PONTA BROCA ROSCA DUPLA CABEÇA SEXTAVADA CUPPED C/ ARRUELA DE EPDM



INOX 302 CAP +  
RUSPERT 1000H

MEDIDA	EQUIV.	CHAVE	PONTA	UN	"PREÇO LISTA"
#12/14-14X2.3/8	5,5X60 MM	5/16"	3	CT	R\$ 749,20
#12/14-14X4	5,5X102 MM	5/16"	4	CT	R\$ 1.251,96

PBS CUPPED INSULATION # 1 / PARAFUSO AUTOPERFORANTE PONTA BROCA # 1 ROSCA DUPLA CABEÇA SEXTAVADA CUPPED C/ ARRUELA DE EPDM



RUSPERT 1000H

MEDIDA	EQUIV.	CHAVE	PONTA	UN	"PREÇO LISTA"
#12/14-14X3.1/4	5,5X80 MM	5/16"	1	CT	R\$ 754,13
#12/14-14X4	5,5X102 MM	5/16"	1	CT	R\$ 902,01

POS CUPPED / PARAF. AUTOP. PONTA # 17 OGIVADA ROSCA HI-LO C/SEXTAVADA CUPPED C/ ARRUELA DE EPDM



BICROMATIZADO  
AMARELO -  
Especial telhas  
metálicas em  
madeira

MEDIDA	EQUIV.	CHAVE	PONTA	UN	"PREÇO LISTA"
#10X1.1/2	4,8X38 MM	5/16"	17	CT	R\$ 145,90
#12X2.1/4	5,5X57 MM	5/16"	17	CT	R\$ 220,82

POS CUPPED / PARAF. AUTOP. PONTA # 17 OGIVADA ROSCA HI-LO CABEÇA SEXTAVADA CUPPED C/ ARRUELA DE EPDM



RUSPERT 1000H  
- Especial telhas  
metálicas em  
madeira

MEDIDA	EQUIV.	CHAVE	PONTA	UN	"PREÇO LISTA"
#10X1.1/2	4,8X38 MM	5/16"	17	CT	R\$ 175,47
#12X2.1/4	5,5X57 MM	5/16"	17	CT	R\$ 290,81

POS CUPPED INSULATION / PAR AUT PONTA # 17 OGIVADA R/DUPLA E HI-LO C/SEXT. CUPPED C/ ARRUELA EPDM



BICROMATIZADO.  
AMARELO  
Especial telhas  
thermo acústicas  
em madeira

MEDIDA	EQUIV.	CHAVE	PONTA	UN	"PREÇO LISTA"
#12/14-14X2.3/4	5,5X70 MM	5/16"	17	CT	R\$ 266,13
#12/14-14X3.1/2	5,5X89 MM	5/16"	17	CT	R\$ 305,59
#12/14-14X4	5,5X102 MM	5/16"	17	CT	R\$ 341,08
#12/14-14X4.1/2	5,5X115 MM	5/16"	17	CT	R\$ 394,32

POS CUPPED INSULATION / PAR AUT PONTA # 17 OGIVADA R/DUPLA E HI-LO C/SEXT CUPPED C/ ARRUELA DE EPDM



RUSPERT 1000H  
Especial telhas  
thermo acústicas  
em madeira

MEDIDA	EQUIV.	CHAVE	PONTA	UN	"PREÇO LISTA"
#12/14-14X2.3/4	5,5X70 MM	5/16"	17	CT	R\$ 474,66
#12/14-14X3.1/2	5,5X89 MM	5/16"	17	CT	R\$ 649,44
#12/14-14X4	5,5X102 MM	5/16"	17	CT	R\$ 748,81
#12/14-14X4.1/2	5,5X115 MM	5/16"	17	CT	R\$ 851,73
#12/14-14X5	5,5X127 MM	5/16"	17	CT	R\$ 1.002,55

POS CUPPED INSULATION / PAR AUT. PONTA # 17 OGIVADA R/DUPLA E HI-LO C/SEXT CUPPED C/ ARRUELA EPDM



RUSPERT 1000H  
COLORS - Especial  
telhas thermo  
acústicas em  
madeira

MEDIDA	EQUIV.	CHAVE	PONTA	UN	"PREÇO LISTA"
#12/14-15X3.1/2	5,5X89 MM	5/16"	17	CT	R\$ 714,70
#12/14-15X3.1/2	5,5X89 MM	5/16"	17	CT	R\$ 714,70

**CONCRETO / PARAFUSO PARA FIXAÇÃO DIRETA EM CONCRETO ROSCA HI-LO CABEÇA SEXTAVADA PHILLIPS**



	MEDIDA	EQUIV.	CHAVE	PONTA	UN	"PREÇO LISTA"
RUSPERT 1000H	#3/16X1.1/4	4,8X32 MM	1/4"	DIAM	CT	R\$ 146,39
	#3/16X1.3/4	4,8X45 MM	1/4"	DIAM	CT	R\$ 184,83
	#1/4X1.3/4	6,3X45 MM	1/4"	DIAM	CT	R\$ 277,01
	#1/4X2.3/4	6,3X70 MM	5/16"	DIAM	CT	R\$ 413,04
	#1/4X4	6,3X102 MM	5/16"	DIAM	CT	R\$ 660,48
	#1/4X5	6,3X125 MM	5/16"	DIAM	CT	R\$ 956,22

**CONCRETO / PARAFUSO PARA FIXAÇÃO DIRETA EM CONCRETO ROSCA HI-LO CABEÇA CHATA PHILLIPS**



	MEDIDA	EQUIV.	CHAVE	PONTA	UN	"PREÇO LISTA"
RUSPERT 1000H	#3/16X1.1/4	4,8X32 MM	PH02	DIAM	CT	R\$ 156,75
	#3/16X1.3/4	4,8X45 MM	PH02	DIAM	CT	R\$ 196,17

**PBS / PARAFUSO AUTOPERFORANTE PONTA BROCA CABEÇA SEXTAVADA**



	MEDIDA	EQUIV.	CHAVE	PONTA	UN	"PREÇO LISTA"
ZINCADO CLARO	4,2X13 MM	#8-18X1/2	1/4"	2	CT	R\$ 33,03
	4,2X16 MM	#8-18X5/8	1/4"	2	CT	R\$ 37,62
	4,2X19 MM	#8-18X3/4	1/4"	2	CT	R\$ 41,13
	4,2X25 MM	#8-18X1	1/4"	2	CT	R\$ 50,56
	4,2X32 MM	#8-18X1.1/4	1/4"	2	CT	R\$ 64,64
	4,2X38 MM	#8-18X1.1/2	1/4"	2	CT	R\$ 74,72
	4,8X16 MM	#10-16X5/8	5/16"	2	CT	R\$ 52,89
	4,8X19 MM	#10-16X3/4	5/16"	2	CT	R\$ 56,91
	4,8X25 MM	#10-16X1	5/16"	2	CT	R\$ 71,36
	5,5X19 MM	#12-14X3/4	5/16"	3	CT	R\$ 77,22
	5,5X25 MM	#12-14X1	5/16"	3	CT	R\$ 88,96
	6,3X25 MM	#14-14X1	3/8"	3	CT	R\$ 128,42

**PBS / PARAFUSO AUTOPERFORANTE PONTA BROCA CABEÇA SEXTAVADA**

	MEDIDA	EQUIV.	CHAVE	PONTA	UN	"PREÇO LISTA"
RUSPERT 1000H	4,2X13 MM	#8-18X1/2	1/4"	2	CT	R\$ 50,79
	4,8X19 MM	#10-16X3/4	5/16"	3	CT	R\$ 55,53
	5,5X19	#12-14X3/4	5/16"	1	CT	R\$ 126,18

**PBS / PARAFUSO AUTOPERFORANTE PONTA BROCA CABEÇA SEXTAVADA**

	MEDIDA	EQUIV.	CHAVE	PONTA	UN	"PREÇO LISTA"
INOX 410 PASSIVADO	4,2X13 MM	#8-18X1/2	1/4"	2	CT	R\$ 79,26
	4,2X16 MM	#8-18X5/8	1/4"	2	CT	R\$ 90,29
	4,2X19 MM	#8-18X3/4	1/4"	2	CT	R\$ 98,72
	4,2X25 MM	#8-18X1	1/4"	2	CT	R\$ 121,34
	4,8X19 MM	#10-16X3/4	5/16"	3	CT	R\$ 136,58
	4,8X25 MM	#10-16X1	5/16"	3	CT	R\$ 171,25

**PBRX / PARAFUSO AUTOPERFORANTE PONTA BROCA CABEÇA REDONDA CHAVE TORX (T-30)**

	MEDIDA	EQUIV.	CHAVE	PONTA	UN	"PREÇO LISTA"
ZINCADO CLARO	6,3X19 MM	#14-14X3/4	T-30	3	CT	R\$ 99,81
	6,3X25 MM	#14-14X1	T-30	3	CT	R\$ 119,77
	6,3X32 MM	#14-14X1.1/4	T-30	3	CT	R\$ 145,65
	6,3X38 MM	#14-14X1.1/2	T-30	3	CT	R\$ 166,36

## PBP / PARAFUSO AUTOPERFORANTE PONTA BROCA CABEÇA PANELA PHILLIPS



ZINCADO CLARO

MEDIDA	EQUIV.	CHAVE	PONTA	UN	"PREÇO LISTA"
2,9X13 MM	#4-24X1/2	PH01	1	CT	R\$ 24,08
2,9X16 MM	#4-24X5/8	PH01	1	CT	R\$ 25,57
2,9X19 MM	#4-24X3/4	PH01	1	CT	R\$ 27,44
2,9X25 MM	#4-24X1	PH01	1	CT	R\$ 34,67
2,9X32 MM	#4-24X1.1/4	PH01	1	CT	R\$ 43,33
3,5X9,5 MM	#6-20X3/8	PH02	2	CT	R\$ 23,29
3,5X11 MM	#6-20X7/16	PH02	2	CT	R\$ 24,51
3,5X13 MM	#6-20X1/2	PH02	2	CT	R\$ 25,80
3,5X16 MM	#6-20X5/8	PH02	2	CT	R\$ 27,41
3,5X19 MM	#6-20X3/4	PH02	2	CT	R\$ 29,40
3,5X25 MM	#6-20X1	PH02	2	CT	R\$ 37,15
3,9X13 MM	#7-19X1/2	PH02	2	CT	R\$ 26,04
3,9X16 MM	#7-19X5/8	PH02	2	CT	R\$ 30,21
3,9X19 MM	#7-19X3/4	PH02	2	CT	R\$ 33,92
4,2X9,5 MM	#8-18X3/8	PH02	2	CT	R\$ 21,46
4,2X13 MM	#8-18X1/2	PH02	2	CT	R\$ 28,29
4,2X16 MM	#8-18X5/8	PH02	2	CT	R\$ 33,12
4,2X19 MM	#8-18X3/4	PH02	2	CT	R\$ 36,03
4,2X25 MM	#8-18X1	PH02	2	CT	R\$ 43,79
4,2X32 MM	#8-18X1.1/4	PH02	2	CT	R\$ 53,40
4,2X38 MM	#8-18X1.1/2	PH02	2	CT	R\$ 59,42
4,2X45 MM	#8-18X1.3/4	PH02	2	CT	R\$ 66,60
4,2X50 MM	#8-18X2	PH02	2	CT	R\$ 76,73
4,8X16 MM	#10-16X5/8	PH02	3	CT	R\$ 47,00
4,8X19 MM	#10-16X3/4	PH02	3	CT	R\$ 52,79
4,8X25 MM	#10-16X1	PH02	3	CT	R\$ 62,06
4,8X32 MM	#10-16X1.1/4	PH02	3	CT	R\$ 77,80
4,8X38 MM	#10-16X1.1/2	PH02	3	CT	R\$ 87,34
4,8X45 MM	#10-16X1.3/4	PH02	3	CT	R\$ 94,62
4,8X50 MM	#10-16X2	PH02	3	CT	R\$ 114,41

## PBP / PARAFUSO AUTOPERFORANTE PONTA BROCA CABEÇA PANELA PHILLIPS



INOX 410  
PASSIVADO

MEDIDA	EQUIV.	CHAVE	PONTA	UN	"PREÇO LISTA"
3,5X13 MM	#6-20X1/2	PH02	2	CT	R\$ 61,93
4,2X13 MM	#8-18X1/2	PH02	2	CT	R\$ 67,91
4,2X16 MM	#8-18X5/8	PH02	2	CT	R\$ 79,49
4,2X19 MM	#8-18X3/4	PH02	2	CT	R\$ 86,47
4,2X25 MM	#8-18X1	PH02	2	CT	R\$ 105,11
4,2X32 MM	#8-18X1.1/4	PH02	2	CT	R\$ 128,16
4,2X38 MM	#8-18X1.1/2	PH02	2	CT	R\$ 142,60
4,8X16 MM	#10-16X5/8	PH02	3	CT	R\$ 112,80
4,8X19 MM	#10-16X3/4	PH02	3	CT	R\$ 126,70
4,8X25 MM	#10-16X1	PH02	3	CT	R\$ 148,93
4,8X32 MM	#10-16X1.1/4	PH02	3	CT	R\$ 186,71
4,8X38 MM	#10-16X1.1/2	PH02	3	CT	R\$ 209,61
4,8X50 MM	#10-16X2	PH02	3	CT	R\$ 274,57

**PBC / PARAFUSO AUTOPERFORANTE PONTA BROCA CABEÇA CHATA PHILLIPS**

**ZINCADO CLARO**

MEDIDA	EQUIV.	CHAVE	PONTA	UN	"PREÇO LISTA"
3,5X13 MM	#6-20X1/2	PH02	2	CT	R\$ 22,73
3,5X16 MM	#6-20X5/8	PH02	2	CT	R\$ 23,50
3,5X19 MM	#6-20X3/4	PH02	2	CT	R\$ 28,16
3,5X25 MM	#6-20X1	PH02	2	CT	R\$ 32,91
3,9X13 MM	#7-19X1/2	PH02	2	CT	R\$ 23,50
3,9X16 MM	#7-19X5/8	PH02	2	CT	R\$ 27,73
3,9X19 MM	#7-19X3/4	PH02	2	CT	R\$ 31,18
3,9X25 MM	#7-19X1	PH02	2	CT	R\$ 37,45
3,9X32 MM	#7-19X1.1/4	PH02	2	CT	R\$ 47,80
3,9X38 MM	#7-19X1.1/2	PH02	2	CT	R\$ 54,99
3,9X45 MM	#7-19X1.3/4	PH02	2	CT	R\$ 64,09
4,2X13 MM	#8-18X1/2	PH02	2	CT	R\$ 25,64
4,2X16 MM	#8-18X5/8	PH02	2	CT	R\$ 29,47
4,2X19 MM	#8-18X3/4	PH02	2	CT	R\$ 33,55
4,2X25 MM	#8-18X1	PH02	2	CT	R\$ 42,63
4,2X32 MM	#8-18X1.1/4	PH02	2	CT	R\$ 49,21
4,2X38 MM	#8-18X1.1/2	PH02	2	CT	R\$ 59,35
4,2X45 MM	#8-18X1.3/4	PH02	2	CT	R\$ 78,73
4,2X50 MM	#8-18X2	PH02	2	CT	R\$ 88,81
4,8X19 MM	#10-16X3/4	PH02	3	CT	R\$ 46,59
4,8X25 MM	#10-16X1	PH02	3	CT	R\$ 59,27
4,8X32 MM	#10-16X1.1/4	PH02	3	CT	R\$ 71,29
4,8X38 MM	#10-16X1.1/2	PH02	3	CT	R\$ 83,14
4,8X45 MM	#10-16X1.3/4	PH02	3	CT	R\$ 91,67
4,8X50 MM	#10-16X2	PH02	3	CT	R\$ 113,37
4,8X63 MM	#10-16X2.1/2	PH02	3	CT	R\$ 150,98
4,0X13 MM	#4-0,7X13	PH02	2	CT	R\$ 22,77
4,0X16 MM	#4-0,7X16	PH02	2	CT	R\$ 24,05
4,0X19 MM	#4-0,7X19	PH02	2	CT	R\$ 28,19
4,0X25 MM	#4-0,7X25	PH02	2	CT	R\$ 32,93
4,0X45 MM	#4-0,7X45	PH02	2	CT	R\$ 49,29

**PBC / PARAFUSO AUTOPERFORANTE PONTA BROCA CABEÇA CHATA PHILLIPS**

**INOX 410 PASSIVADO**

MEDIDA	EQUIV.	CHAVE	PONTA	UN	"PREÇO LISTA"
3,9X13 MM	#7-19X1/2	PH02	2	CT	R\$ 56,41
3,9X16 MM	#7-19X5/8	PH02	2	CT	R\$ 66,57
3,9X19 MM	#7-19X3/4	PH02	2	CT	R\$ 74,83
3,9X25 MM	#7-19X1	PH02	2	CT	R\$ 89,89
4,2X13 MM	#8-18X1/2	PH02	2	CT	R\$ 61,54
4,2X16 MM	#8-18X5/8	PH02	2	CT	R\$ 70,73
4,2X19 MM	#8-18X3/4	PH02	2	CT	R\$ 80,50
4,2X25 MM	#8-18X1	PH02	2	CT	R\$ 102,30
4,2X32 MM	#8-18X1.1/4	PH02	2	CT	R\$ 118,09
4,2X38 MM	#8-18X1.1/2	PH02	2	CT	R\$ 142,43
4,8X19 MM	#10-16X3/4	PH02	3	CT	R\$ 111,52
4,8X25 MM	#10-16X1	PH02	3	CT	R\$ 142,24
4,8X32 MM	#10-16X1.1/4	PH02	3	CT	R\$ 171,10
4,8X38 MM	#10-16X1.1/2	PH02	3	CT	R\$ 199,54
4,8X50 MM	#10-16X2	PH02	3	CT	R\$ 272,09

**PBF / PARAFUSO AUTOPERFORANTE PONTA BROCA CABEÇA FLANGEADA PHILLIPS**

**ZINCADO CLARO**

MEDIDA	EQUIV.	CHAVE	PONTA	UN	"PREÇO LISTA"
4,2X11 MM	#8-18X7/16	PH02	2	CT	R\$ 26,68
4,2X13 MM	#8-18X1/2	PH02	2	CT	R\$ 29,65
4,2X13 MM	#8-18X1/2	PH02	2	CT	R\$ 29,65
4,2X16 MM	#8-18X5/8	PH02	2	CT	R\$ 32,15
4,2X19 MM	#8-18X3/4	PH02	2	CT	R\$ 35,08
4,2X25 MM	#8-18X1	PH02	2	CT	R\$ 42,28
4,2X32 MM	#8-18X1.1/4	PH02	2	CT	R\$ 50,64
4,2X38 MM	#8-18X1.1/2	PH02	2	CT	R\$ 57,57
4,2X45 MM	#8-18X1.3/4	PH02	2	CT	R\$ 74,07
4,2X50 MM	#8-18X2	PH02	2	CT	R\$ 100,55
4,2X63 MM	#8-18X2.1/2	PH02	2	CT	R\$ 114,80
4,8X19 MM	#10-16X3/4	PH02	2	CT	R\$ 55,20



PBF / PARAFUSO AUTOPERFORANTE PONTA BROCA CABEÇA FLANGEADA PHILLIPS COLORS



ZINCADO CLARO

MEDIDA	EQUIV.	CHAVE	PONTA	UN	"PREÇO LISTA"
4,2X13 MM	#8-18X1/2	PH02	2	CT	R\$ 59,30
4,2X19 MM	#8-18X3/4	PH02	2	CT	R\$ 70,17

PBF / PARAFUSO AUTOPERFORANTE PONTA BROCA CABEÇA FLANGEADA PHILLIPS



RUSPERT 1000H

MEDIDA	EQUIV.	CHAVE	PONTA	UN	"PREÇO LISTA"
4,2X13 MM	#8-18X1/2	PH02	2	CT	R\$ 40,03
4,2X19 MM	#8-18X3/4	PH02	2	CT	R\$ 47,37
4,8X19 MM	#10-16X3/4	PH02	2	CT	R\$ 74,53

PBF / PARAFUSO AUTOPERFORANTE PONTA BROCA CABEÇA FLANGEADA PHILLIPS



INOX 410  
PASSIVADO

MEDIDA	EQUIV.	CHAVE	PONTA	UN	"PREÇO LISTA"
4,2X13 MM	# 8-18X1/2	PH02	2	CT	R\$ 71,17
4,2X16 MM	# 8-18X5/8	PH02	2	CT	R\$ 77,15
4,2X19 MM	# 8-18X3/4	PH02	2	CT	R\$ 84,20
4,2X25 MM	#8-18X1	PH02	2	CT	R\$ 101,47
4,2X32 MM	#8-18X1.1/4	PH02	2	CT	R\$ 121,52
4,2X38 MM	#8-18X1.1/2	PH02	2	CT	R\$ 138,17

PBT / PARAFUSO AUTOPERFORANTE PONTA BROCA CABEÇA TROMBETA PHILLIPS



FOSFATIZADO  
PRETO

MEDIDA	EQUIV.	CHAVE	PONTA	UN	"PREÇO LISTA"
3,5X25 MM	#6-20X1	PH02	2	CT	R\$ 27,26
3,5X35 MM	#6-20X1.3/8	PH02	2	CT	R\$ 36,23
3,5X45 MM	#6-20X1.3/4	PH02	2	CT	R\$ 44,36
3,5X57 MM	#6-20X2.1/4	PH02	2	CT	R\$ 64,66
4,2X76 MM	#8-18X3	PH02	2	CT	R\$ 110,41

PBEA / PARAF AUTOP PONTA BROCA CABEÇA CHATA PHILLIPS C/ ESTRIAS ESCARIADORAS E ASAS DE EXPANSÃO



RUSPERT 1000H  
Especial para fixa-  
ção madeira em  
metal

MEDIDA	EQUIV.	CHAVE	PONTA	UN	"PREÇO LISTA"
4,2X25 MM	#8-18X1	PH02	2	CT	R\$ 64,07
4,2X32 MM	#8-18X1.1/4	PH02	2	CT	R\$ 91,67
4,2X45 MM	#8-18X1.3/4	PH02	2	CT	R\$ 126,18
5,5X76 MM	#12-14X3	PH03	4	CT	R\$ 259,27

PBEA / PARAF AUTOP PONTA BROCA CABEÇA CHATA PHILLIPS C/ ESTRIAS ESCARIADORAS E ASAS DE EXPANSÃO



BICROMATIZADO  
AMARELO  
Especial para  
fixação madeira  
em metal

MEDIDA	EQUIV.	CHAVE	PONTA	UN	"PREÇO LISTA"
5,5X38 MM	#12-14X1.1/2	PH03	3	CT	R\$ 104,47
5,5X45 MM	#12-14X1.3/4	PH03	3	CT	R\$ 119,92
5,5X50 MM	#12-14X2	PH03	3	CT	R\$ 132,25
5,5X57 MM	#12-14X2.1/4	PH03	3	CT	R\$ 155,01
5,5X63 MM	#12-14X2.1/2	PH03	3	CT	R\$ 162,96
5,5X76 MM	#12-14X3	PH03	4	CT	R\$ 199,45
5,5X82 MM	#12-14X3.1/4	PH03	3	CT	R\$ 229,34
6,3X127 MM	#14-20X5	PH03	3	CT	R\$ 459,38

**PBEA / PARAF AUTOP PONTA BROCA CABEÇA CHATA PHILLIPS C/ ESTRIAS ESCARIADORAS E ASAS DE EXPANSÃO**

**BICROMATIZADO AMARELO**

Especial para fixação madeira em metal

MEDIDA	EQUIV.	CHAVE	PONTA	UN	"PREÇO LISTA"
5,5X45 MM	#12-14X1.3/4	T-25	3	CT	R\$ 119,92
5,5X50 MM	#12-14X2	T-25	3	CT	R\$ 132,25
5,5X57 MM	#12-14X2.1/4	T-25	3	CT	R\$ 155,01

**PBA / PARAF AUTOP PONTA BROCA CABEÇA CHATA PHILLIPS C/ ASAS DE EXPANSÃO**

**ZINCADO**

Especial para fixação madeira em metal

MEDIDA	EQUIV.	CHAVE	PONTA	UN	"PREÇO LISTA"
5,5X38 MM	#12-14X1.1/2	PH03	3	CT	R\$ 104,47
5,5X57 MM	#12-14X2.1/4	PH03	3	CT	R\$ 155,01

**PBEE / PARAFUSO AUTOPERFORANTE PONTA BROCA CABEÇA CHATA ESCALONADA PHILLIPS C/ 8 ESTRIAS ESCARIADORAS**

**RUSPERT 1000H**

Especial para fixação placa cimentícia

MEDIDA	EQUIV.	CHAVE	PONTA	UN	"PREÇO LISTA"
4,2X32 MM	#8-18X1.1/4	PH02	2	CT	R\$ 105,48
4,2X45 MM	#8-18X1.3/4	PH02	2	CT	R\$ 136,04
4,8X50 MM	#10-16X2	PH02	3	CT	R\$ 210,96

**PAEE / PARAFUSO AUTOP PONTA ESPADA ROSCA HI-LO CABEÇA CHATA ESCALONADA PHILLIPS C/ 8 ESTRIAS ESCARIADORAS**

**RUSPERT 1000H**

Especial para fixação placa cimentícia

MEDIDA	EQUIV.	CHAVE	PONTA	UN	"PREÇO LISTA"
4,2X32 MM	#8X1.1/4	PH02	ESPADA	CT	R\$ 113,37

**MF-FU / BUCHA UNIVERSAL TIPO FU MULTI-USO EM NYLON**

MEDIDA	EQUIV.	CHAVE	PONTA	UN	"PREÇO LISTA"
6 X 35MM	COM ANEL	UNIV		CT	R\$ 46,02
8 X 50MM	COM ANEL	UNIV		CT	R\$ 103,71
10 X 60MM	COM ANEL	UNIV		CT	R\$ 184,00

**MF-U / BUCHA UNIVERSAL DE TORSÃO MULTI-USO EM NYLON**

MEDIDA	EQUIV.	CHAVE	PONTA	UN	"PREÇO LISTA"
6 X 38MM	COM ANEL	UNIV	U-6	CT	R\$ 42,11
8 X 51MM	COM ANEL	UNIV	U-8	CT	R\$ 81,08
10 X 61MM	COM ANEL	UNIV	U-10	CT	R\$ 154,39

**MF-B / BUCHA BORBOLETA EM NYLON**

MEDIDA	EQUIV.	CHAVE	PONTA	UN	"PREÇO LISTA"
BASE 4 A 16MM	T: 65 KGF	MF-B2		CT	R\$ 134,07
BASE 16 A 22MM	T: 65 KGF	MF-B3		CT	R\$ 159,21
BASE 24 A 32MM	T: 65 KGF	MF-B4		CT	R\$ 201,10

MF-S / BUCHA DE FIXAÇÃO EM NYLON (PONTA DE ESTOQUE)



MEDIDA	EQUIV.	CHAVE	PONTA	UN	"PREÇO LISTA"
12X60 MM	SEM ANEL	S-12		CT	R\$ 79,49

PBE-Mad / PARAFUSO AUTOPERFORANTE PONTA BROCA CABEÇA CHATA TORX / PHILLIPS C/ ESTRIAS ESCARIADORAS ROSCA MADEIRA (PONTA DE ESTOQUE)



MEDIDA	EQUIV.	CHAVE	PONTA	UN	"PREÇO LISTA"
#4X25 MM	TORX	T-20		CT	R\$ 34,11
#4X45 MM	TORX	T-20		CT	R\$ 54,74
#4X70 MM	TORX	T-20		CT	R\$ 82,92
#4X40 MM	TORX	T-15		CT	R\$ 47,79
#4X45 MM	TORX	T-15		CT	R\$ 54,74
#4X50 MM	TORX	T-15		CT	R\$ 61,05
#4X25 MM	PHILLIPS	PH02		CT	R\$ 34,11

# Hastes de Fixação de Telhas Inove-Fix para máxima resistência

Garanta a segurança e durabilidade de suas telhas de fibrocimento com as Hastes de Fixação **Inove-Fix**! Desenvolvidas com materiais de alta qualidade, nossas hastes galvanizadas oferecem resistência excepcional contra aderência, garantindo uma fixação robusta e confiável. Com o **Inove-Fix**, você tem a tranquilidade de proteger seu telhado contra ventos fortes e condições climáticas adversas. Não arrisque, escolha a qualidade das Hastes de Fixação **Inove-Fix** e tenha certeza de uma cobertura resistente e duradoura. Entre em contato conosco e descubra a solução perfeita para seus projetos de telhado!

Material  
AÇO BAIXO CARBONO  
E ACABAMENTO ZINCADO



## **Linha porcas e arruelas**

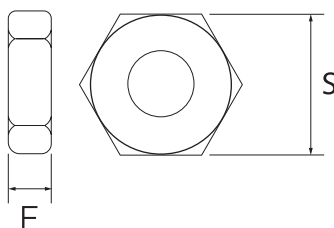

## Porca Sextavada

Material: Aço baixo carbono  
Acabamento: Zincado ou Bícromatizado

S			Preço cento	S (máx.)	F (máx.)	Rosca - fio/passos
1/8"	POLEGADA - GRAU 2	R\$ 14,24	1/4"	2,90	UNC-40	
5/32"	POLEGADA - GRAU 2	R\$ 18,89	1/4"	2,90	UNC-32	
5/32"	POLEGADA - GRAU 2	R\$ 18,89	5/16"	3,30	UNC-32	
3/16"	POLEGADA - GRAU 2	R\$ 19,95	5/16"	4,20	UNC-24	
1/4"	POLEGADA - GRAU 2	R\$ 42,22	7/16"	5,74	UNC-20	
5/16"	POLEGADA - GRAU 2	R\$ 55,57	1/2"	6,93	UNC-18	
3/8"	POLEGADA - GRAU 2	R\$ 76,58	9/16"	8,56	UNC-16	
1/2"	POLEGADA - GRAU 2	R\$ 169,49	3/4"	11,38	BSW-12	
1/2"	POLEGADA - GRAU 2	R\$ 169,49	3/4"	11,38	UNC-13	
5/8"	POLEGADA - GRAU 2	R\$ 322,62	15/16"	14,20	UNC-11	
3/4"	POLEGADA - GRAU 2	R\$ 546,59	1.1/8"	16,89	UNC-10	
7/8"	POLEGADA - GRAU 2	R\$ 863,28	1.5/16"	19,71	UNC-9	
1"	POLEGADA - GRAU 2	R\$ 1.284,70	1.1/2"	22,53	UNC-8	
M5	MÉTRICO - CLASSE 6	R\$ 19,18	8	4,00	0,80	
M6	MÉTRICO - CLASSE 6	R\$ 60,32	10	5,00	1,00	
M8	MÉTRICO - CLASSE 6	R\$ 61,57	13	6,50	1,25	
M10	MÉTRICO - CLASSE 6	R\$ 112,10	17	8,00	1,50	
M12	MÉTRICO - CLASSE 6	R\$ 158,94	19	10,00	1,75	

Preço de lista por cento

# Porca Sextavada 1/4 da Inovefix!

## FIXAÇÃO SEGURA E DURADOURA

A Porca Sextavada 1/4 da Inovefix é uma peça de fixação altamente confiável e durável. Fabricada com materiais de alta qualidade, ela oferece resistência superior e é capaz de suportar cargas elevadas, garantindo uma fixação segura em várias aplicações. Com sua rosca sextavada padrão de 1/4, a porca proporciona uma conexão estável e livre de folgas, evitando deslizamentos indesejados.

A Porca Sextavada 1/4 da Inovefix é amplamente utilizada em montagem de móveis, construção civil, instalações elétricas e hidráulicas, bem como em projetos industriais, sendo a escolha ideal para profissionais que buscam qualidade e segurança em suas fixações.





## Linha Rebites

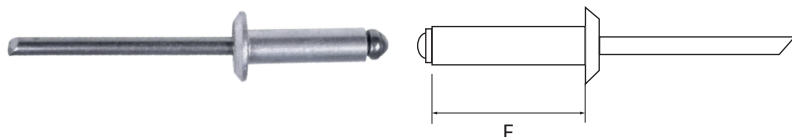

## Rebite de repuxo Alumínio

Material do prego: Aço baixo carbono  
Material ilhós: Alumínio

S		300		400		500		600	
		peso (kg/mil)	peso (kg/mil)	peso (kg/mil)	peso (kg/mil)	peso (kg/mil)	peso (kg/mil)	peso (kg/mil)	peso (kg/mil)
6	R\$ 246,38	0,927	R\$ 337,61	1,432					
8	R\$ 248,15	1,035	R\$ 351,69	1,478	R\$ 494,62	2,528			
10	R\$ 254,47	1,063	R\$ 355,83	1,546	R\$ 521,34	2,590	R\$ 804,40	3,609	
12	R\$ 262,06	1,094	R\$ 372,02	1,592	R\$ 544,53	2,656	R\$ 860,39	3,726	
14	R\$ 277,92	1,123	R\$ 424,80	1,808	R\$ 592,59	2,862	R\$ 916,46	3,843	
16	R\$ 279,94	1,252	R\$ 430,36	1,854	R\$ 629,36	2,923	R\$ 997,33	4,431	
19	R\$ 316,70	1,296	R\$ 466,71	2,035	R\$ 709,38	3,301	R\$ 1.031,22	4,604	
22	R\$ 471,34	1,478	R\$ 605,16	2,102	R\$ 760,05	3,512	R\$ 1.191,85	4,998	
25	R\$ 511,56	1,522	R\$ 649,51	2,173	R\$ 828,27	3,604	R\$ 1.248,01	5,171	
30					R\$ 1.075,15	4,074	R\$ 1.511,34	5,713	
35					R\$ 1.113,10	4,712	R\$ 1.648,18	6,702	
40					R\$ 1.226,93	4,880	R\$ 1.732,76	7,002	

Preço de lista por milheiro

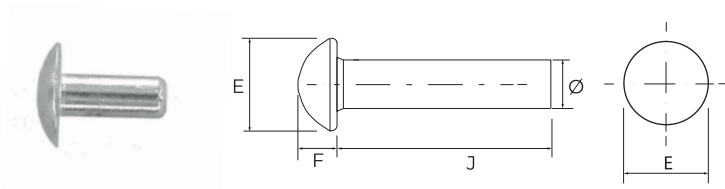

## Rebite Maciço Alumínio cabeça lentilha

Material: Alumínio 1350/5005  
Acabamento: Polido

### Dimensões

Diâmetro	1/8"	5/32"	3/16"	1/4"	5/16"
E (máx)	7,54	9,34	12,10	14,98	18,59
F (máx)	1,21	1,49	2,20	2,31	2,87

J	3/16"	R\$ 578,34	R\$ 489,37		
1/4"	R\$ 545,89	R\$ 471,91	R\$ 428,72		
5/16"	R\$ 522,55	R\$ 458,69	R\$ 422,52	R\$ 399,44	
3/8"	R\$ 504,03	R\$ 448,34	R\$ 417,39	R\$ 396,10	R\$ 412,30
7/16"	R\$ 489,37	R\$ 440,02	R\$ 413,03	R\$ 393,32	R\$ 408,51
1/2"	R\$ 477,47	R\$ 433,07	R\$ 409,36	R\$ 390,98	R\$ 405,25
9/16"	R\$ 467,62	R\$ 427,36	R\$ 406,20	R\$ 388,99	R\$ 402,45
5/8"	R\$ 459,34	R\$ 422,52	R\$ 403,44	R\$ 387,25	R\$ 399,98
3/4"	R\$ 446,18	R\$ 414,75	R\$ 398,84	R\$ 384,40	R\$ 395,88
7/8"	R\$ 436,19	R\$ 408,77	R\$ 395,21	R\$ 382,16	R\$ 392,61
1"	R\$ 428,35	R\$ 404,01	R\$ 392,23	R\$ 380,35	R\$ 389,92
1.1/4"	R\$ 416,90	R\$ 397,00	R\$ 387,71	R\$ 377,60	R\$ 385,81
1.1/2"	R\$ 408,82	R\$ 392,03	R\$ 384,39	R\$ 375,61	R\$ 382,80
1.3/4"		R\$ 388,35	R\$ 381,87	R\$ 374,11	R\$ 380,49
2"		R\$ 385,49	R\$ 379,89	R\$ 372,93	R\$ 378,68

Preço de lista por cento

## Rebite Maciço

### Alumínio cabeça redonda

Material: Alumínio 1350/5005  
Acabamento: Polido

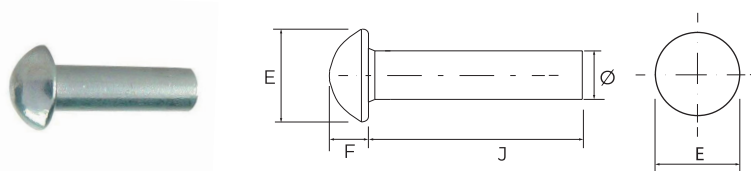

### Dimensões

Diâmetro	1/8"	5/32"	3/16"	1/4"	5/16"
E (máx)	5,96	7,36	8,83	11,68	14,52
F (máx)	2,54	3,14	3,73	4,97	6,17

J	3/16"	R\$ 563,12	R\$ 484,13			
1/4"	R\$ 534,80	R\$ 468,38	R\$ 436,80			
5/16"	R\$ 513,51	R\$ 456,65	R\$ 429,07	R\$ 395,65		
3/8"	R\$ 496,92	R\$ 446,96	R\$ 422,80	R\$ 392,95	R\$ 406,87	
7/16"	R\$ 483,63	R\$ 439,22	R\$ 417,63	R\$ 390,66	R\$ 403,84	
1/2"	R\$ 472,75	R\$ 432,79	R\$ 413,23	R\$ 388,70	R\$ 401,20	
9/16"	R\$ 463,91	R\$ 427,36	R\$ 409,58	R\$ 387,01	R\$ 398,90	
5/8"	R\$ 456,18	R\$ 422,73	R\$ 406,35	R\$ 385,53	R\$ 396,85	
3/4"	R\$ 443,82	R\$ 415,14	R\$ 401,13	R\$ 383,05	R\$ 393,38	
7/8"	R\$ 434,36	R\$ 409,33	R\$ 397,02	R\$ 381,07	R\$ 390,57	
1"	R\$ 426,88	R\$ 404,68	R\$ 393,73	R\$ 379,45	R\$ 388,23	
1.1/4"	R\$ 415,90	R\$ 397,70	R\$ 388,75	R\$ 376,96	R\$ 384,59	
1.1/2"	R\$ 408,10	R\$ 392,76	R\$ 385,17	R\$ 375,14	R\$ 381,87	
1.3/4"		R\$ 389,04	R\$ 382,48	R\$ 373,74	R\$ 379,77	
2"		R\$ 386,17	R\$ 380,37	R\$ 372,64	R\$ 378,09	

Preço de lista por cento

## Rebite Maciço

### Alumínio cabeça plana

Material: Alumínio 1350/5005  
Acabamento: Polido

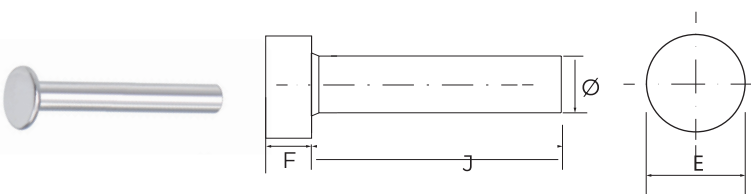

### Dimensões

Diâmetro	1/8"	5/32"	3/16"	1/4"	5/16"
E (máx)	6,60	8,20	9,82	13,08	16,28
B (máx)	1,21	1,49	1,75	2,31	2,87

J	3/16"	R\$ 556,73	R\$ 475,35			
1/4"	R\$ 530,07	R\$ 461,34	R\$ 435,94			
5/16"	R\$ 510,38	R\$ 450,45	R\$ 428,46	R\$ 395,35		
3/8"	R\$ 494,44	R\$ 441,73	R\$ 422,24	R\$ 392,70	R\$ 406,69	
7/16"	R\$ 481,62	R\$ 434,47	R\$ 417,16	R\$ 390,45	R\$ 403,69	
1/2"	R\$ 471,08	R\$ 428,55	R\$ 412,88	R\$ 388,52	R\$ 401,06	
9/16"	R\$ 462,26	R\$ 423,53	R\$ 409,24	R\$ 386,85	R\$ 398,78	
5/8"	R\$ 454,78	R\$ 419,24	R\$ 406,09	R\$ 385,39	R\$ 396,74	
3/4"	R\$ 442,76	R\$ 412,25	R\$ 400,90	R\$ 382,94	R\$ 393,29	
7/8"	R\$ 433,53	R\$ 406,77	R\$ 396,86	R\$ 380,98	R\$ 390,50	
1"	R\$ 426,32	R\$ 402,42	R\$ 393,58	R\$ 379,38	R\$ 388,17	
1.1/4"	R\$ 415,44	R\$ 395,88	R\$ 388,65	R\$ 376,91	R\$ 384,54	
1.1/2"	R\$ 407,77	R\$ 391,23	R\$ 385,10	R\$ 375,10	R\$ 381,84	
1.3/4"		R\$ 387,73	R\$ 382,42	R\$ 373,71	R\$ 379,74	
2"		R\$ 383,26	R\$ 378,97	R\$ 371,90	R\$ 376,98	

Preço de lista por cento



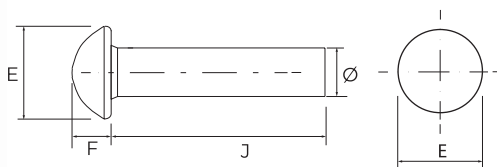

## Rebite Maciço Ferro cabeça redonda

Material: Aço baixo carbono  
Acabamento: Polido

### Dimensões

Diâmetro	1/8"	5/32"	3/16"	1/4"	5/16"	3/8"	1/2"
E (máx)	6,60	8,20	9,82	13,08	16,28	19,53	25,80
F (máx)	1,21	1,49	1,75	2,31	2,87	3,42	4,50

J	3/16"	R\$ 165,96						
1/4"	R\$ 158,38	R\$ 135,32	R\$ 116,76	R\$ 122,45				
5/16"	R\$ 150,23	R\$ 130,48	R\$ 113,95	R\$ 119,51	R\$ 106,67			
3/8"	R\$ 143,89	R\$ 126,64	R\$ 111,67	R\$ 117,05	R\$ 105,42	R\$ 99,66		
7/16"	R\$ 138,80	R\$ 123,48	R\$ 109,78	R\$ 114,97	R\$ 104,35	R\$ 99,06		
1/2"	R\$ 139,17	R\$ 120,88	R\$ 108,20	R\$ 113,19	R\$ 103,42	R\$ 98,52		
9/16"	R\$ 135,35		R\$ 106,86					
5/8"	R\$ 132,09	R\$ 116,79	R\$ 106,61	R\$ 110,30	R\$ 101,89	R\$ 97,63		
3/4"	R\$ 126,86	R\$ 145,35	R\$ 103,79	R\$ 108,04	R\$ 100,66	R\$ 96,90	R\$ 93,06	
7/8"	R\$ 122,87	R\$ 139,45	R\$ 102,31	R\$ 106,24	R\$ 99,67	R\$ 96,30	R\$ 92,82	
1"	R\$ 119,71	R\$ 134,72	R\$ 101,11	R\$ 104,77	R\$ 98,85	R\$ 95,80	R\$ 92,62	
1.1/4"	R\$ 148,56	R\$ 127,66	R\$ 99,30	R\$ 102,50	R\$ 97,56	R\$ 95,00	R\$ 92,29	
1.1/2"	R\$ 140,32	R\$ 122,63	R\$ 98,00	R\$ 100,84	R\$ 96,60	R\$ 94,40	R\$ 92,04	
1.3/4"	R\$ 134,20	R\$ 118,87	R\$ 97,02	R\$ 99,57	R\$ 95,86	R\$ 93,93	R\$ 91,84	
2"	R\$ 129,47	R\$ 115,95	R\$ 96,25	R\$ 98,57	R\$ 95,27	R\$ 93,55	R\$ 91,67	

Preço de lista por cento

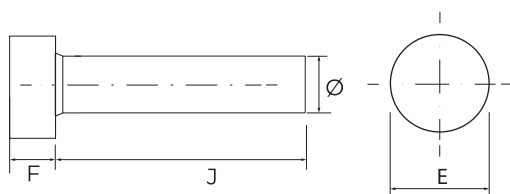

## Rebite Maciço Ferro cabeça plana

Material: Aço baixo carbono  
Acabamento: Polido

### Dimensões

Diâmetro	1/8"	5/32"	3/16"	1/4"	5/16"	3/8"	1/2"
E (máx)	6,60	8,20	9,82	13,08	16,28	19,53	25,80
B (máx)	1,21	1,49	1,75	2,31	2,87	3,42	4,50

J	3/16"	R\$ 163,64						
1/4"	R\$ 153,87	R\$ 130,21	R\$ 116,46	R\$ 102,84				
5/16"	R\$ 146,54	R\$ 126,05	R\$ 113,71	R\$ 101,70	R\$ 106,59			
3/8"	R\$ 140,72	R\$ 122,72	R\$ 111,47	R\$ 100,73	R\$ 105,36	R\$ 99,68		
7/16"	R\$ 136,04	R\$ 119,98	R\$ 109,62					
1/2"	R\$ 132,19	R\$ 117,70	R\$ 108,06	R\$ 99,21	R\$ 103,37	R\$ 98,53		
9/16"	R\$ 129,00		R\$ 106,74					
5/8"	R\$ 126,26	R\$ 114,14	R\$ 105,59	R\$ 98,08	R\$ 101,85	R\$ 97,63		
3/4"	R\$ 121,86	R\$ 111,46	R\$ 103,71	R\$ 97,19	R\$ 100,63	R\$ 96,91	R\$ 93,10	
7/8"	R\$ 118,48	R\$ 109,38	R\$ 102,24	R\$ 96,48	R\$ 99,65	R\$ 96,31	R\$ 92,86	
1"	R\$ 115,80	R\$ 109,33	R\$ 101,05	R\$ 95,89	R\$ 98,83	R\$ 95,80	R\$ 92,65	
1.1/4"	R\$ 114,85	R\$ 106,57	R\$ 99,26	R\$ 95,00	R\$ 97,55	R\$ 95,00	R\$ 92,32	
1.1/2"	R\$ 111,61	R\$ 104,59	R\$ 97,97	R\$ 94,34	R\$ 96,59	R\$ 94,40	R\$ 92,06	
1.3/4"	R\$ 109,19	R\$ 103,11	R\$ 97,00	R\$ 93,83	R\$ 95,85	R\$ 93,93	R\$ 91,85	
2"	R\$ 106,13	R\$ 101,21	R\$ 104,33	R\$ 97,89	R\$ 94,88	R\$ 93,30	R\$ 91,57	

Preço de lista por cento